

KUHNS MFG LLC



# Owner's Manual

## Tie Grabber Series

2013



Operator's Manual For The Kuhns MFG LLC Tie Grabber Series

**MADE IN THE USA** 

*Read and Understand the manual. This manual provides information and procedures to safely operate and maintain the KN615 Tie Grabber.*





# Contents

<b>SAFETY</b> .....	<b>3</b>
General .....	3
Safety Alert Symbols .....	3
Safety Icons Nomenclature .....	4
General Operating Safety .....	5
Safety Signs .....	5
Practice Safe Maintenance .....	5
<b>DEFINITIONS</b> .....	<b>6</b>
<b>SPECIFICATIONS</b> .....	<b>6</b>
<b>INTRODUCTION</b> .....	<b>6</b>
<b>TIE GRABBER ATTACHMENT</b> .....	<b>6</b>
Mounting onto Front End Loader or Skid Steer Loader .....	6
Hydraulic Connections .....	6
Hydraulic Block Port Identification .....	6
(Version 1 Manifold) .....	6
(Version 2 Manifold) .....	7
Connecting Hoses to Machine .....	7
Conventional Method (Four Ports) .....	7
Optional Method (Splitter Attachment) .....	8
<b>THREADING TWINE INTO THE TWINE ARM</b> .....	<b>9</b>
<b>OPERATION</b> .....	<b>11</b>
Safety .....	11
Tie Grabber Operation .....	11
Operation Using Optional Hydraulic Splitter Valves .....	13
Knotter Operation .....	13
<b>MAINTENANCE</b> .....	<b>15</b>
Flow Control Valve .....	15
Setting Early Versions .....	15
Setting Current Versions .....	15
Setting Priority Valve (early versions) .....	15
Sequence Valves .....	16
Setting Early Version Sequence Valves .....	16
Setting Current Version Sequence Valves .....	16
Twine Arm Drive Chain .....	16
Knotter Drive Chain .....	17
Twine Guides .....	17
Twine Tensioner .....	17
Knotter Stop Plate Spring .....	17
Needle Position Within the Knotter .....	17
Twine Arm Stop Bumper .....	19
Tucker Finger Adjustment .....	20
Accessing Knotter Components .....	20
Bill Hook Adjustment .....	20
Twine Disc Assembly .....	20
Twine Clamping Force .....	21
Knife Arm .....	21
Stripping Arm .....	21
Cam Gear Adjustment .....	22

<b>LUBRICATION</b> .....	<b>22</b>
Main Frame . . . . .	22
Knotter Lubrication. . . . .	23
<b>STORAGE</b> .....	<b>24</b>
<b>MANIFOLD HOSE AND VALVE LOCATIONS</b> .....	<b>26</b>
<b>TROUBLESHOOTING</b> .....	<b>28</b>
<b>TROUBLESHOOTING VALVE SETTINGS</b> .....	<b>31</b>
<b>PARTS SECTION</b> .....	<b>32</b>
Ordering Parts . . . . .	32
Contact Information . . . . .	32
Decals . . . . .	32
Tie Grabber Frame and Squeeze Arm. . . . .	33
Bale Hook Assembly. . . . .	34
Twine Arm and Motor Assembly . . . . .	35
Knotter Assembly . . . . .	36
Hose Assemblies . . . . .	38

# Safety

## General

Most work related accidents are caused by failure to observe basic safety rules or precautions. An accident can often be avoided by recognizing potentially hazardous situations before an accident occurs. As you operate and maintain the Tie Grabber you must be alert to potential hazards. You should also have the necessary training, skills, and tools to perform any assembly procedure.

**Improper operation and/or maintenance of this unit could cause a dangerous situation that results in injury or death.**

**Do not use this unit until you read and understand the information contained in this manual. Do not use the Tie Grabber for anything other than its intended purpose.**



Do not use the unit until you read and understand the information contained in this manual.



Safety precautions and warnings are provided in this manual and on the unit. If these hazard warnings are not heeded, bodily injury or death could occur to you or to other persons.

Kuhns Manufacturing cannot anticipate every possible circumstance that might involve a potential hazard. The warnings in this manual and on the product are, therefore, not all-inclusive. If a method of operation not specifically recommended by us is used, you must satisfy yourself that it is safe for you and for others. You should also ensure that the unit will not be damaged or be made unsafe by the methods that you choose.

The information, specifications, and illustrations in this manual are based on the information that was available at the time this material was written and can change at any time.

## Safety Alert Symbols



This is the safety alert symbol. It is used to alert you to potential personal injury hazards. Obey all safety messages that follow this symbol to avoid possible injury or death.

This manual contains DANGERS, WARNINGS, CAUTIONS, IMPORTANT NOTICES, and NOTES which must be followed to prevent the possibility of improper service, damage to the equipment, personal injury, or death. The following key words call the readers attention to potential hazards.

Hazards are identified by the "Safety Alert Symbol" and followed by a signal word such as "DANGER", "WARNING", or "CAUTION".



**Indicates an imminently hazardous situation which, if not avoided, will result in death or serious injury. This signal word is limited to the most extreme situations.**



**Indicates a potentially hazardous situation which, if not avoided, could result in death or serious injury.**



**Indicates a potentially hazardous situation which, if not avoided, may result in minor or moderate injury.**



*Indicates that equipment or property damage can result if instructions are not followed.*























**Safety instructions (or equivalent) signs indicate specific safety-related instructions or procedures.**

**Note:** Contains additional information important to a procedure.

## Safety Icons Nomenclature

This manual and the equipment has numerous safety icons. These safety icons provide important operating instructions which alert you to potential personal injury hazards

-  Read the manual
-  Maintenance procedure
-  Eye protection
-  Hand protection
-  Inspect equipment
-  Do not weld
-  Use proper tools
-  Warning decal alert
-  Stop machine engine
-  Check/Maintain Fluid Levels
-  Place in neutral
-  Remove key
-  Stop engine
-  Set parking brake
-  No riders
-  No children
-  Crushing hazard
-  Crushing hazard
-  Falling hazard
-  Fire hazard
-  Hot surface

-  Safety alert symbol
-  Sharp object hazard
-  Zero pressure
-  Entanglement hazard
-  Defective or broken part
-  Maintain safe distance
-  Pinch point hazard
-  Pinch point hazard
-  Pinch point hazard
-  Electrocution hazard
-  Tip over hazard



## General Operating Safety

### **DANGER**

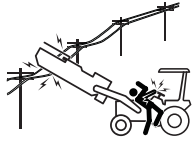

**Electrocution Hazard**  
Despite operating precautions, equipment can come in contact with electrical lines. It is important to know how to handle these situations.

If the machine comes in contact with overhead power lines, stay on the machine. Ask someone to contact the local utility company immediately to remove the danger. If there's an emergency, such as an electrical fire, and you need to leave the equipment, jump as far away from the equipment as possible. Do not allow any part of your body to touch the equipment and the ground at the same time.

Once you get away from the equipment, never attempt to get back on or even touch the equipment. Many electrocutions occur when the operator dismounts and, realizing nothing has happened, tries to get back on the equipment.

### **WARNING**



**Read And Understand Manual**

To prevent personal injury or even death, be sure you read and understand all of the instructions in this manual and other related OEM equipment manuals! This Tie Grabber (unit) was designed for a specific application; DO NOT modify or use this unit for any application other than which it was designed. Units operated improperly or by untrained personnel can be dangerous! Inexperienced operators should receive instruction from someone familiar with the equipment before being allowed to operate the unit.



**Do Not Operate**

Do not use the unit if it is in need of repair. If you believe the unit has a defect which could cause injury or death, you should immediately stop using the unit.



**Fall Hazard**

Do not use the unit as a platform. Do not stand on top of the unit at any time. Do not ride on the unit or allow others to ride on it.



**Entanglement Hazard**

Keep hands, feet, clothing, jewelry, and long hair away from any moving parts to prevent them from getting caught.

## Safety Signs

### **CAUTION**



**Legible Safety Signs**

Keep safety signs clean and legible at all times. Replace any safety sign or instruction sign that is missing or not legible. Refer to the Safety Sign Location section for additional information.

Replacement parts that displayed a safety sign should also display the current sign.

Replacement safety signs (labels) are available from your authorized Dealer Parts Department or the factory at no cost.

## Practice Safe Maintenance

### **SAFETY INSTRUCTIONS**



Understand service procedures before doing any work. Keep the work area clean and dry.



Keep all parts in good working condition and properly installed. Replace worn or broken parts immediately.



Do not modify the unit or its safety devices. Do not weld on the unit. Unauthorized modifications may impair its function and safety.

## Definitions

Machine - Either a front end loader or a skid steer loader.

Unit - One of the available Tie Grabber attachments.

## Specifications

The following charts provides the minimum lifting capacity of the machine.

### **WARNING**



Tip Over Hazard

**Using an under-rated machine can cause the machine to tip over, resulting in serious injury or even possible death. Attach the unit only to a machine with the proper lifting capacity.**

Model Number	Minimum Machine Lifting Capacity
KN618	2800 lbs. (1270 kg)
KN615	2500 lbs. (1134 kg)
KN510	2100 lbs. (950 kg)
KN612F	2300 lbs. (1040 kg)
KN510F	2200 lbs. (1000 kg)
KN410F	2100 lbs. (950 kg)
KN408F	2000 lbs. (905 kg)

## Introduction

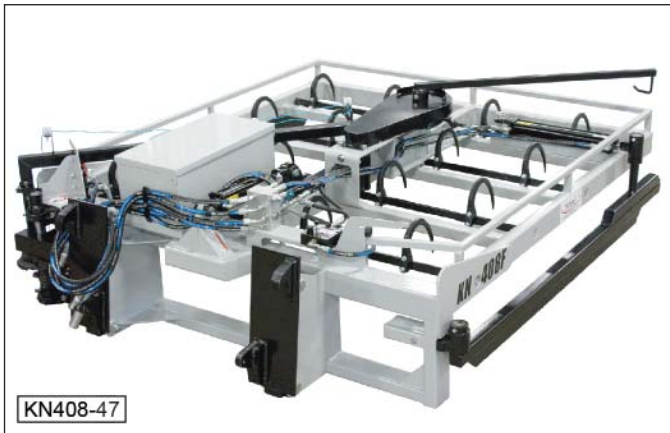

The Tie-Grabber automatically places twine around a group of bales that are deposited by the accumulator. Picking up a complete grouping of eight to eighteen bales of hay at one time allows wagons to be loaded more quickly as well as quicker stacking in the barn.

With a completely bundled grouping of hay bales, it also provides significant time savings as the need for load tie-downs is diminished to almost zero.

## Tie Grabber Attachment

### Mounting onto Front End Loader or Skid Steer Loader

The units come equipped with either a front end loader mounting bracket or a skid steer mounting bracket.

Follow the OEM machine manufacturer's recommendations for attaching the machine to the tie grabber attachment.

Many units have a bolt-on attachment bracket that will allow the end user to use the same unit with various machines. The bolt-on brackets are factory installed according to the sales order.

### Hydraulic Connections

The tie grabber requires four separate hydraulic hose connections to operate properly.

**Note:** If the machine is equipped with only two hydraulic connections, a hydraulic splitter or two additional hoses must be added to the machine. Since there is such a wide variety of machines on the market today, contact the machine's OEM for recommendations on adding the additional hydraulic capability.

### Hydraulic Block Port Identification

(Version 1 Manifold)

The four hydraulic ports are:

Port 1 — Used to release or raise the bale hooks and open the squeeze arm.

Port 2 — Used to close the squeeze arm and set or lower the bale hooks.

Port 3 — Used to return the twine arm to its retracted position.

Port 4 — Used to extend the twine arm around the bales and rotate the knoter.

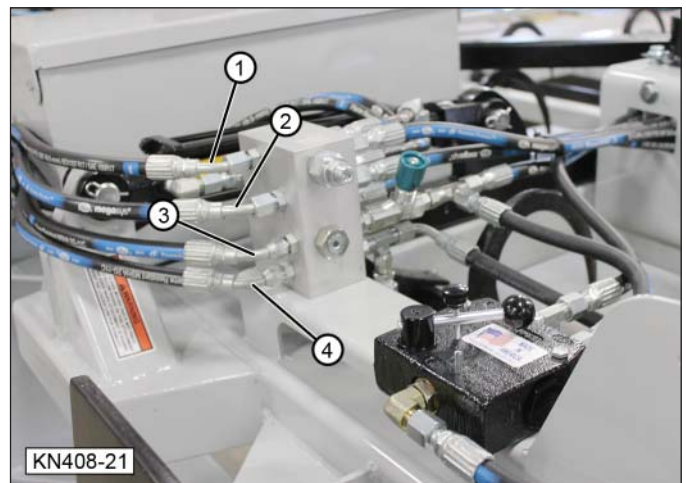



(Version 2 Manifold)

The four hydraulic ports are:

Port 1 — Used to release or raise the bale hooks and open the squeeze arm.

Port 2 — Used to close the squeeze arm and set or lower the bale hooks.

Port 3 — Used to return the twine arm to its retracted position.

Port 4 — Used to extend the twine arm around the bales and rotate the knotter.

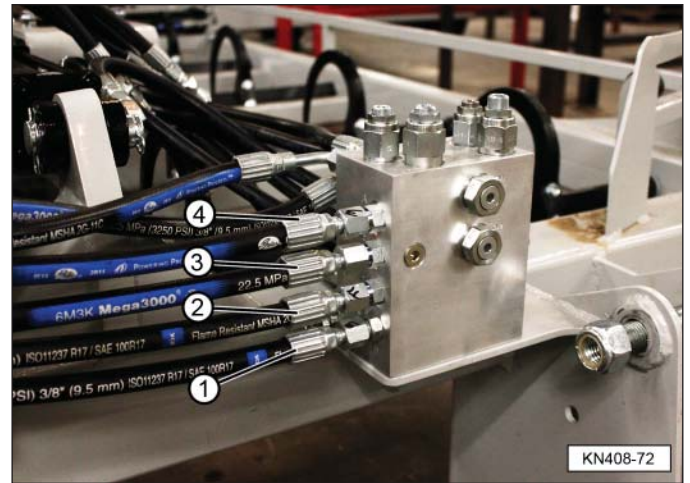
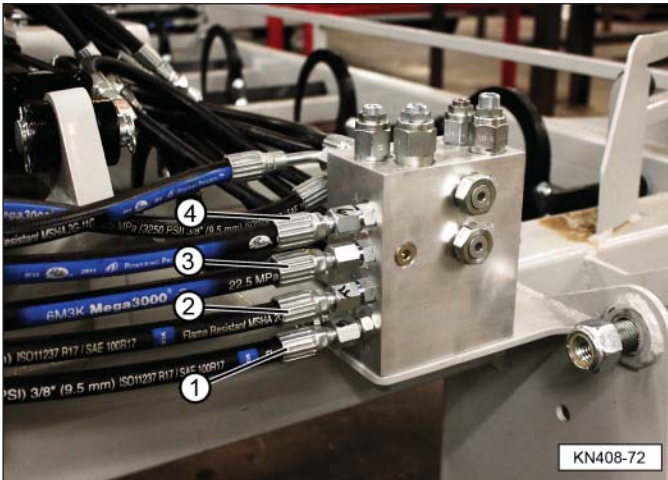

Version 2 Manifold

The connection of the hoses to the machine dictates the operation of the unit. For example, if the twine arm moves forward when the machine's control is pulled back, reversing the hoses will make the twine arm operate in reverse.

**Note:** The operating controls should be set to the end users preference.

## NOTICE



**Check the machine's hydraulic reservoir, after connecting and cycling the unit, for proper fluid level. Operating the machine without the proper oil level can cause machine damage.**

### Connecting Hoses to Machine Conventional Method (Four Ports)

Connect hoses (1) and (2) into one circuit on the machine. Connect hoses (3) and (4) into a second circuit on the machine. If four ports are not available on the machine, an optional splitter valve kit is available.

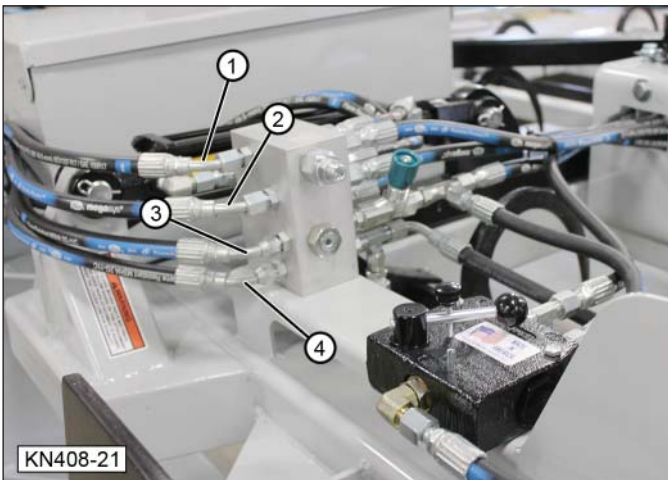

Version 1 Manifold

## Optional Method (Splitter Attachment)

The optional splitter valve kit allows the tie grabber to operate using the two standard attachment ports found on most machines. The optional valve allows the operator to divert oil flow from the squeeze arm and bale hook circuit to the swing arm and knotter circuit by simply pushing and holding a button.



1. Connect two valves (5) into the hydraulic circuit ports.

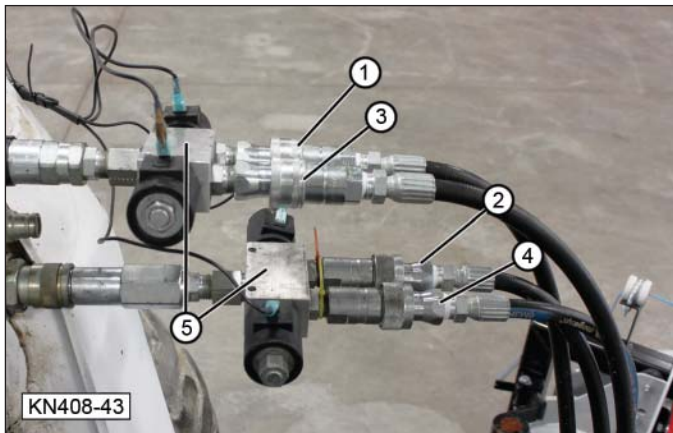

**Note:** Valves (5) are stamped with a number 1 and number 2 on the face of the valve for each port. To function properly, connect the inlet and outlet of one circuit into the same port. For example the hoses from one circuit are connected to Ports 1 of each valve.

**Note:** Connect hoses (1) and (2) to Ports 1 on the valve. Connect hoses (3) and (4) to Ports 2 on the valve. Without pushing the button, the squeeze arm close and twine arm extends should function. When the button is pushed and held, the twine arm will retract and the squeeze arm will open.



2. Connect the outlet (1) and inlet (2) hoses for the squeeze arm and bale hook circuit to the splitter valve ports marked number 1. Connect the outlet (3) and inlet (4) hoses for the swing arm and knotter circuit to the splitter valve ports marked number 2.

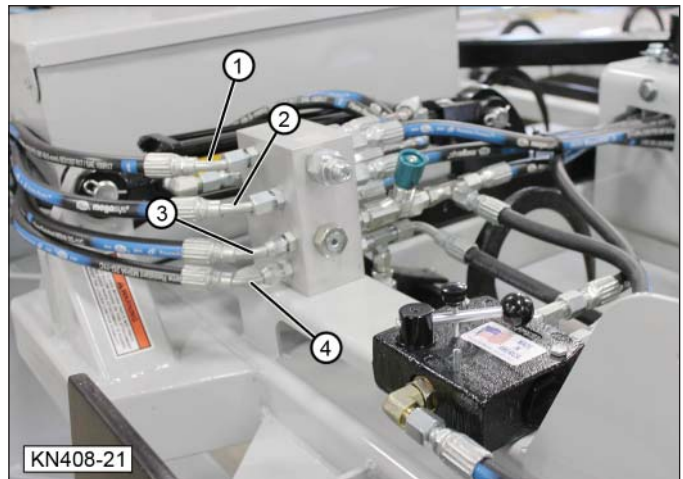

Version 1 Manifold

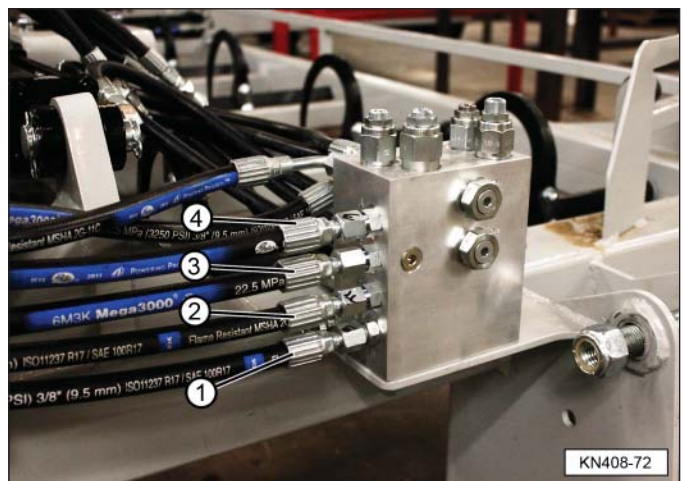

Version 2 Manifold



- Route and secure control wires (6) from the valves, along the bucket arm, and into the cab.

## NOTICE

To prevent damage, route the wire in such a manner that it will not be damaged when the liftarms of the machine raise or lower the tie grabber.



- Mount the control button in the cab.

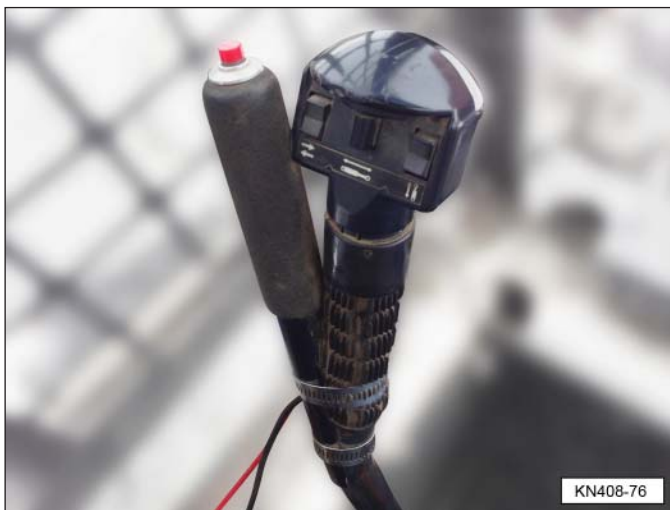

- Connect the two power wires to a 12 Volt power source.

Tie Grabber

**Note:** The operating direction of the twine arm and the squeeze arm/hooks should be set to the end users preference.

## NOTICE



Check the machine's hydraulic reservoir, after connecting and cycling the unit, for proper fluid level. Operating the machine without the proper oil level can cause machine damage.

## Threading Twine into the Twine Arm

- Press and hold the lever/control for the "Twine Arm Forward" circuit to rotate the twine arm, to the position shown, approximately three feet from the knotter.

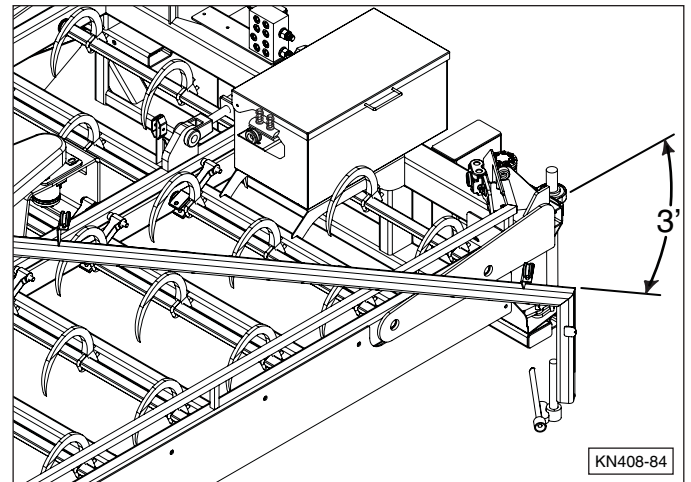

- Stop the machine.

## CAUTION



CRUSHING HAZARD  
Stop the

machine on flat ground before leaving the machine and/or continuing the twine threading operation, always make sure the machine's engine is stopped, the ignition key is removed, all controls are placed in neutral, the parking brake is set, and all hydraulic fluid pressure is relieved (zero pressure). Failure to follow these instructions can result in serious injury.

- Place the twine spool in the box on top of the unit.

**Note:** A plastic twine with a 9000-130 rating is recommended for this unit. In many cases two rolls of twine can be spliced together by tying a small knot and trimming the ends as close as possible to the knot. This small knot will in most cases thread through the eyelets.

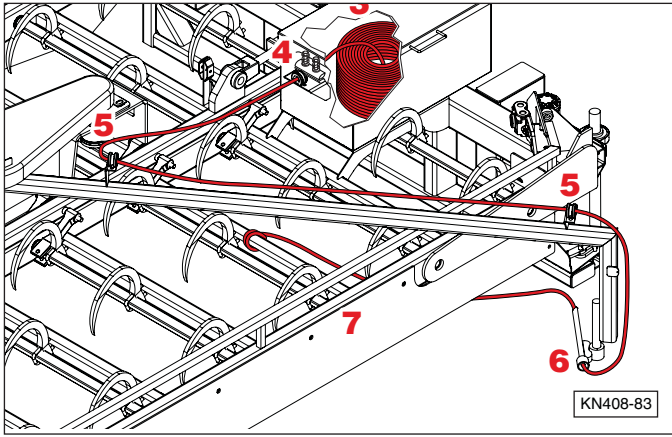

4. Thread the twine through the tension bars and through the first twine eyelet.
5. Thread the twine through the two eyelets on the twine arm as shown.
6. Thread the twine through the needle assembly.
7. Tie the end of the twine to a frame member, as shown.

**Note:** Tying the end of the twine too close to the knotter assembly can cause it to thread the twine incorrectly.

8. Make sure everyone is standing clear of the twine arm. Start the machine.

**CAUTION**



**CRUSHING HAZARD**  
Do not stand near the unit when the twine arm is in motion. Contact with the twine arm while it is rotating can cause serious injury. Keep all children and bystanders away from unit while it is operating.

**it is rotating can cause serious injury. Keep all children and bystanders away from unit while it is operating.**

9. Press and hold the lever/control for the “Twine Arm Forward” circuit to extend the needle into the knotter.

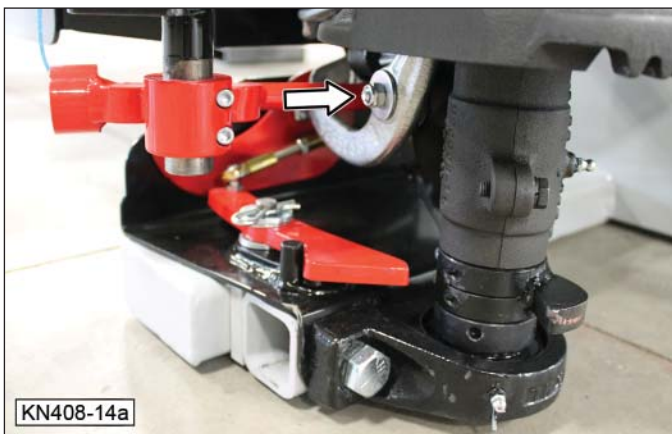

10. Press and hold the lever/control for the “Twine Arm Return” circuit to return the twine arm to its retracted position.



11. Remove the short piece of twine that was tied to the frame rail in Step 7.

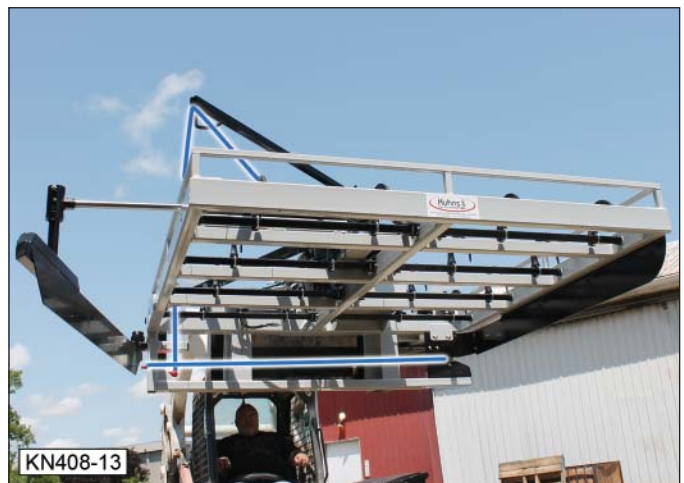

12. The unit should now be correctly threaded with twine and ready for operation.



# Operation

## Safety

### **⚠ WARNING**

Not following these safety instructions can result in serious injury and possible death.



Read and understand the Operator's Manual and all safety signs before operating the unit.



Do not allow riders on the unit or the machine.



Stop machine's engine, remove ignition key, and wait for all moving parts to stop before leaving the machine.



Keep all bystanders, especially children, away from the machine and the unit when loading or unloading.



Keep hands, feet, hair, and clothing away from rotating parts.



Do not place hands, fingers, or arms between moving parts.



Stay away from overhead power lines. Electrocutation can occur without direct contact.

## Tie Grabber Operation

1. If necessary, reset the twine arm.



2. Position the unit over the bales. Driving slightly forward and to the right will condense the bales into a more compact grouping.

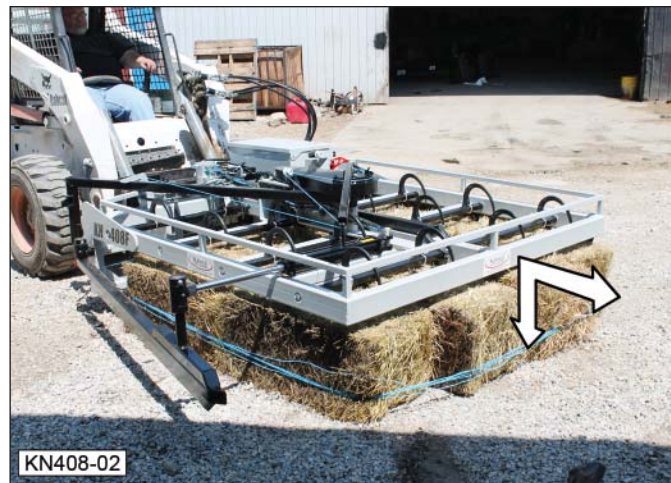

3. Press and hold the lever/control for the "Close Squeeze Arm" circuit. Releasing the lever at any point in the operation will stop the movement.



4. Continue to hold the "Close Squeeze Arm" lever/control and once the squeeze arm is fully closed, the hooks will automatically extend into the bales. Lift the bales.





- Press and hold the lever/control for the “Twine Arm Forward” circuit to extend the twine arm around the bales. Releasing the lever at any point in the operation will stop the movement.



- Continue to hold the “Twine Arm Forward” lever/control and once the twine arm needle threads the twine completely, the knotter assembly will automatically tie the twine. Do not release the lever/control while the knotter is in operation.



- Set the bales in the desired location.
- Use the lever/control to release the hooks. As soon as the hooks have released, release the lever/control. This will prevent the squeeze arm from opening.

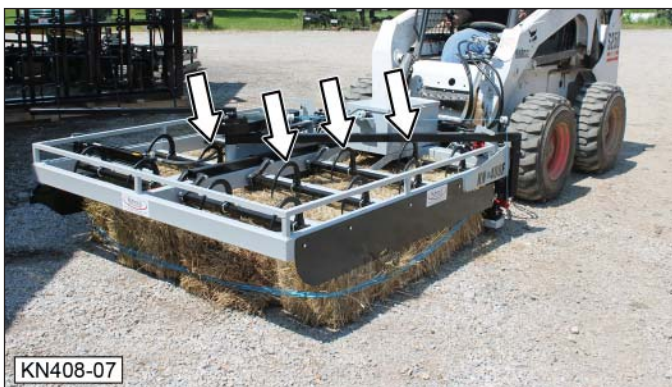

**Note:** In some cases, fully opening the squeeze arm without lifting the unit off of the bales, can cause the twine to break.

- Lift the unit straight above the bales and back out.



- Once clear of the bales, activate the squeeze arm open circuit to open the squeeze arm.



- Press and hold the lever/control for the “Twine Arm Return” circuit until the twine arm returns to its retracted position and then release the lever/control. Releasing the lever at any point in the operation will stop the movement.





## Operation Using Optional Hydraulic Splitter Valves

1. Position the unit over the bales.
2. Close the squeeze arm. (Do not push the button.)
3. Set the bale hooks. (Do not push the button.)
4. Lift the bales.
5. Press the button and actuate the twine arm. Once the knotter has cycled, release the button.
6. Set the bales in the desired location.
7. Push the button and release the bale hooks. Once the bale hooks are free of the bales, release the control lever before the squeeze arm opens.

**Note:** In some cases, fully opening the squeeze arm without lifting the unit off of the bales can cause the twine to break.

8. Lift the unit straight up and off of the bales and move away.
9. Push the button and actuate the control lever again to open the squeeze arm.
10. Push the button and reset the twine arm.

## Knotter Operation

1. The needle brings the twine into the knotter.

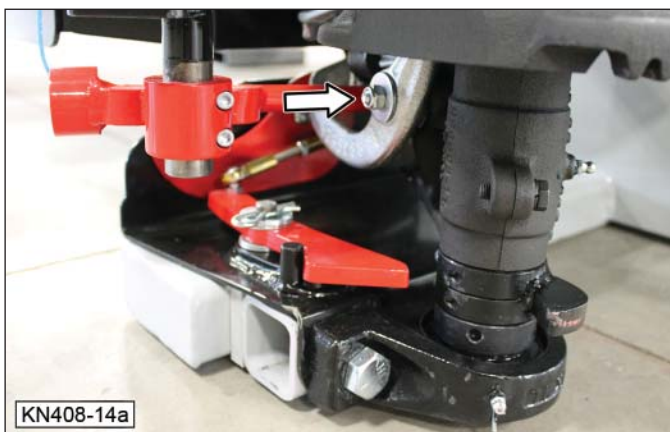
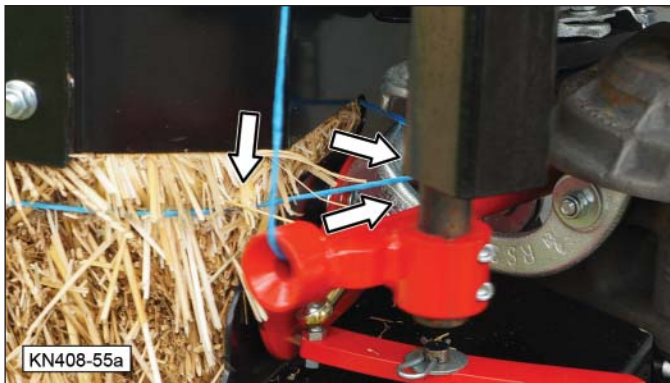

2. At the same time the needle goes into the knotter, the twine arm presses down on the actuation plate (a) which presses on the adjustment bolt (b) and opens the flow control valve. This sends hydraulic fluid to the motor which rotates the knotter mechanism.



## NOTICE



Hydraulic oil flow through the valve is controlled by the adjustment bolt. A 1/16 inch gap is recommended between the snap ring and the valve body. Damage will occur to the valve spool if the snap ring contacts the valve body.

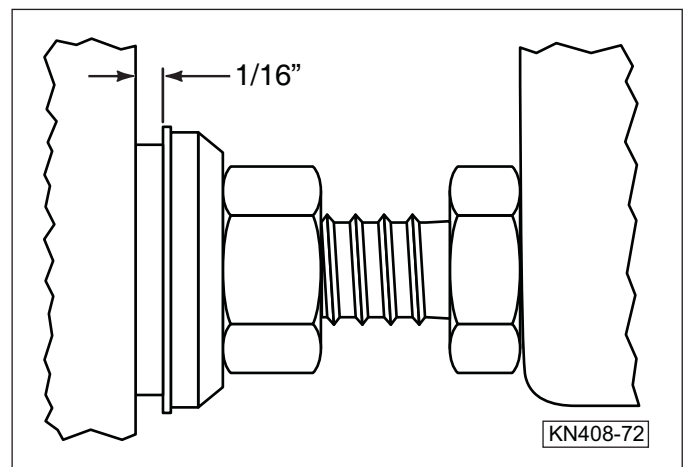

- The hydraulic motor, through the drive chain, turns the shaft for the knoter assembly. As the cam (1) on the shaft rotates, it contacts the rocker arm (2) which then extends the tucker finger and presses the twine into the knoter.

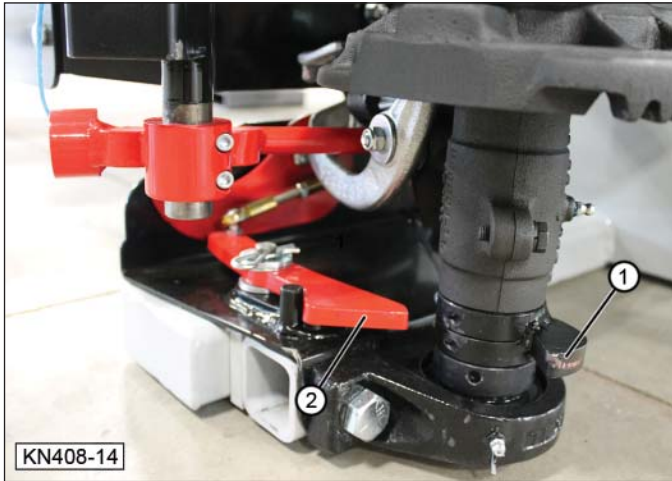

When the twine arm returns to its retracted position, the actuation plate releases the flow control valve and stops hydraulic oil flow to the motor. The motor stop plate (4), part of the twine arm, is also retracted. Since there is no hydraulic flow to the motor it is positioned for the next cycle.



- With the needle extended through the knoter, the knoter then takes the twine and ties the knot.



- As the knoter assembly finishes tying the knot, the shaft has rotated and contacts knoter stop plate (4). This plate prevents the knoter from further rotation.

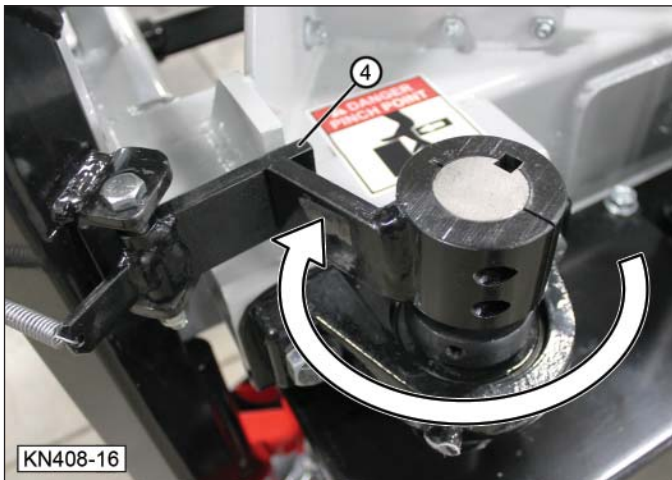



## Maintenance

### Flow Control Valve

#### Setting Early Versions

The flow control needle valve restricts the flow of oil to the twine arm. Adjusting the control knob sets the speed at which the twine arm returns to its retracted position.

Setting the speed too high can cause the twine arm to contact the frame with too much force, causing damage to the twine arm, or the frame.

Setting the speed too low can stop the twine arm from returning to its retracted position.

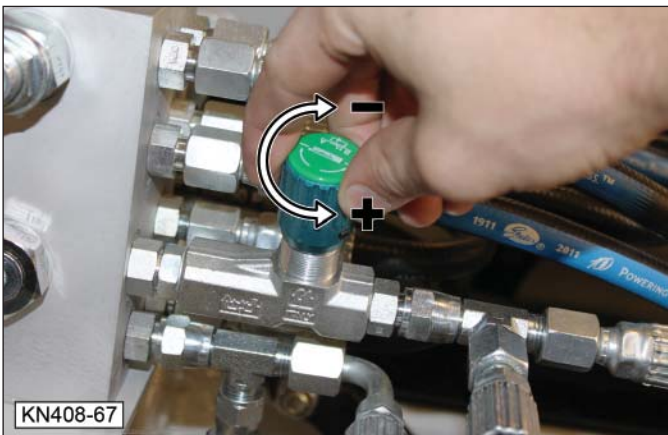
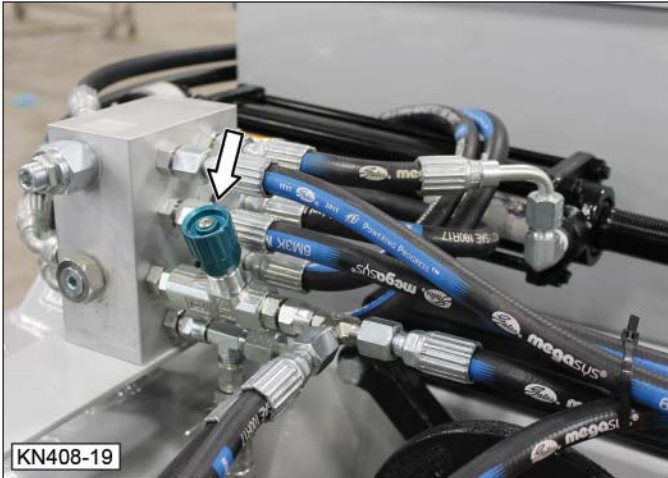

Turn the control knob counterclockwise to increase the speed (flow). Turn the control knob clockwise to decrease the speed.

#### Setting Current Versions

Refer to the troubleshooting section for specifications to set these valves.

### Setting Priority Valve (early versions)

The priority valve controls the speed of the twine arm as it extends into the knotter.

The recommended setting for this valve is Position 4. Once valve handle (1) is properly set, tighten locking mechanism (2) to retain this setting.

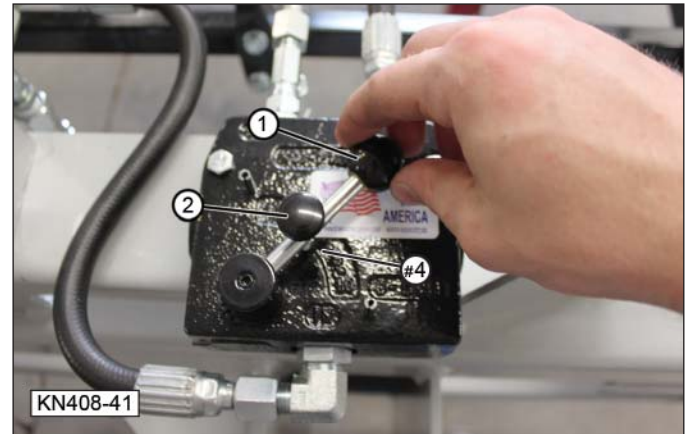

Setting the speed too high can will cause the twine arm to contact the rubber stop at the end of its travel with too much force. Setting the speed too low can cause the knotter not to rotate or turn too slowly to properly tie the knot.

## Sequence Valves

The sequence valves are factory preset. If the valves need to be replaced or adjusted, call the factory for further instructions.

The sequence valves are used to cycle the unit between various functions. When the hydraulic oil pressure reaches the desired setting for the initial function, the oil flow is diverted to the second function. For example, when the squeeze arm clamps onto the bales, the pressure builds and then the sequence valve directs the flow to the bale hooks which lower into the bales.

### Setting Early Version Sequence Valves

Sequence Valve 1 — Twine arm extend to knotter assembly.

Sequence Valve 2 — Squeeze arm close; hooks extend.

Flow Control Valve 3 — Speed of twine arm to retracted position.

Sequence Valve 4 — Hooks retract; Squeeze arm open.

Check Valve 5 — Prevents backward rotation of knotter.

Priority Valve 6 — Speed of twine arm to extended position (into knotter assembly).

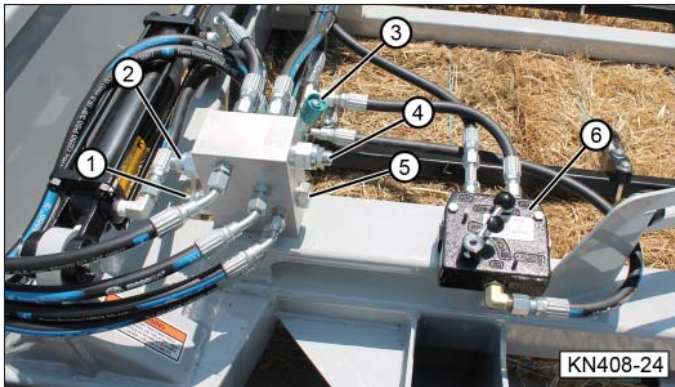

### Sequence Valve Configuration for Version 1.

#### Setting Current Version Sequence Valves

Refer to the troubleshooting section for specifications to set these valves.

## Twine Arm Drive Chain

Periodically check the chain that operates the twine arm. There should be approximately 1/2 inch (12 mm) of play in the chain.



To adjust the tension on the chain, loosen four bolts (1) and adjust bolt (2) to achieve the proper chain tension.





## Knotter Drive Chain

Periodically check the chain that operates the twine arm. There should be approximately 1/8 inch to 1/4 inch of play in the chain.



To adjust the tension on the chain, loosen four bolts (1) and adjust bolt (2) to achieve the proper chain tension.

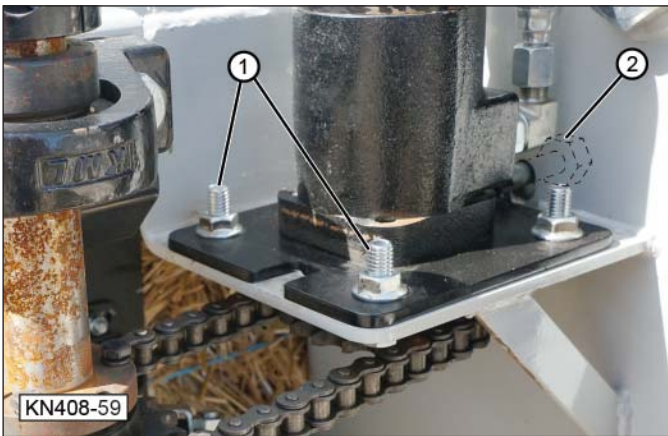

## Twine Guides

Twine guides (1) can be replaced. Do not overtighten U-bolt (2) when installing guides.

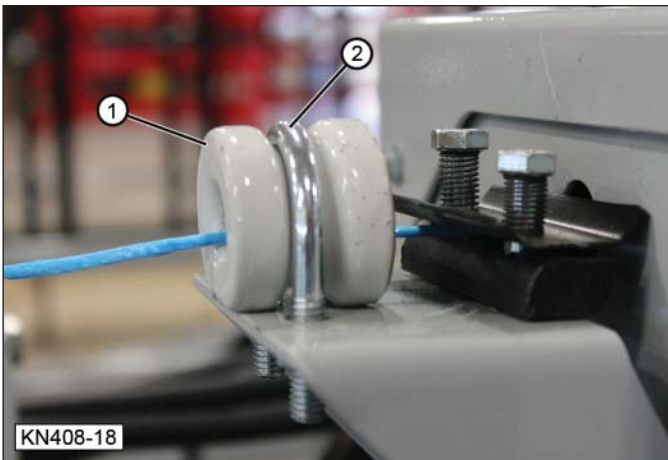

## Twine Tensioner

The twine tension can be increased or decreased using bolts (3) to vary the spring pressure on spring plate (2). If rubber twine guide (1) becomes grooved it can be removed and turned over.

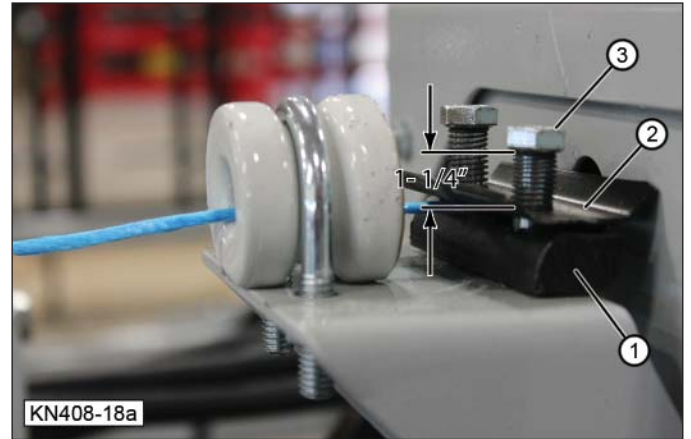

## Knotter Stop Plate Spring

If the spring, attached to the knotter stop plate is missing or damaged, the knotter will not work properly.



## Needle Position Within the Knotter

When properly set, the outside of the needle should be 1/8 inch from the face of the twine holder.

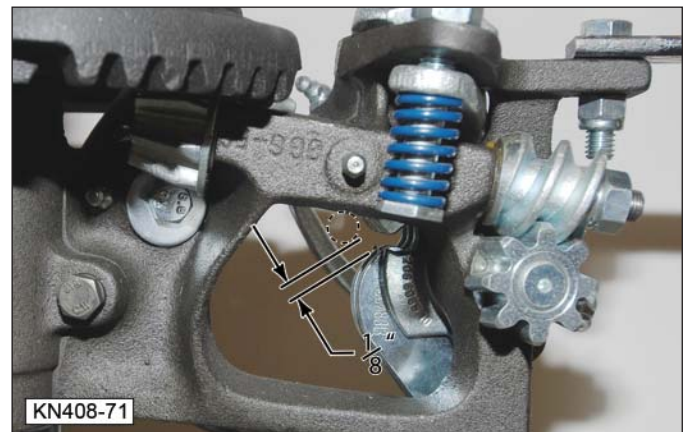

## Testing and Adjusting Knotter Assembly

To test or adjust the knotter, remove the knotter drive chain and turn the knotter by hand. This shows each part working and allows any necessary adjustments.

### **CAUTION**



#### **PINCH POINT**

Keep hands and fingers away from rotating and/or mating parts to prevent injury.

1. These two illustrations show the twine with strand (1a) coming into the knotter from the back side of the unit. The other end of the twine, strand (1b) is coming around the bales and through the needle.

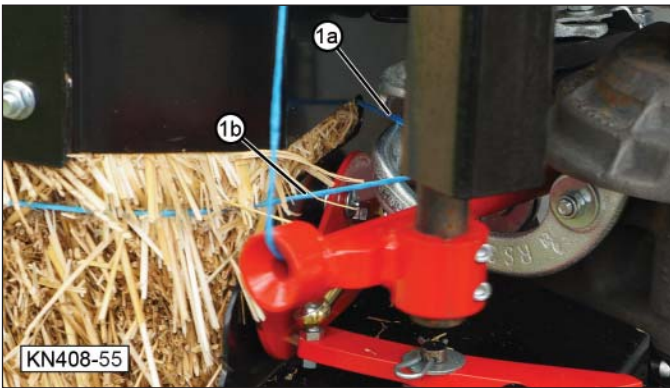

2. When tucker finger (2) is in the down position, as shown, bill hook finger (3) should also be pointed down.



3. As the knotter cycles, cam (3) on the knotter shaft contacts and rotates rocker arm (4) causing tucker finger (2) to push the twine into the knotter.

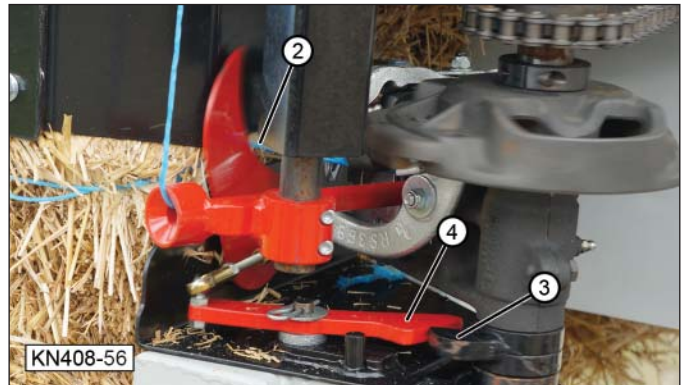

4. If tucker finger (2) does not push the twine far enough into the knotter, bill hook finger (5) will not properly catch the twine and the knot may or may not be tied correctly.

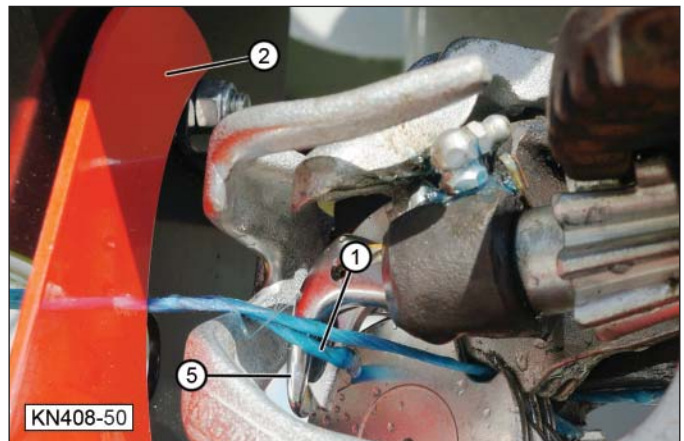

**Note:** The needle is not shown in these illustrations to clearly show the position of twine (1).



5. Tucker finger (2) holds twine (1) as bill hook finger (5) rotates upward. If the bill hook finger does not catch both strands of twine, the tucker finger may need to be adjusted inward.

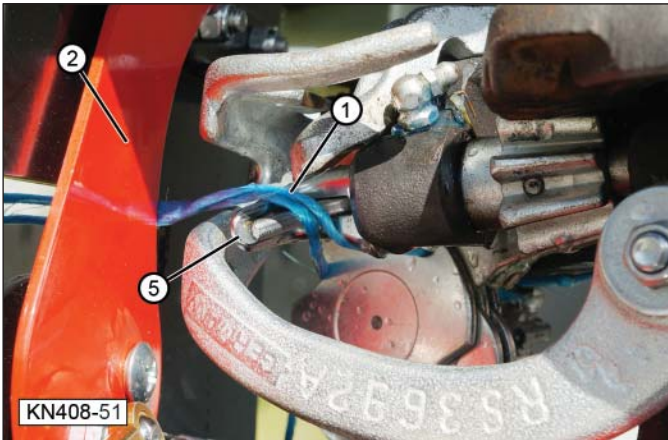

6. The bill hook finger continues to rotate. In this illustration, the bill hook finger has made one half revolution. At this point, Cam (3) is about to release the rocker arm and allow the tucker finger to return to its normal position. If spring (6) is broken, stretched, or missing the knotter will not function properly.

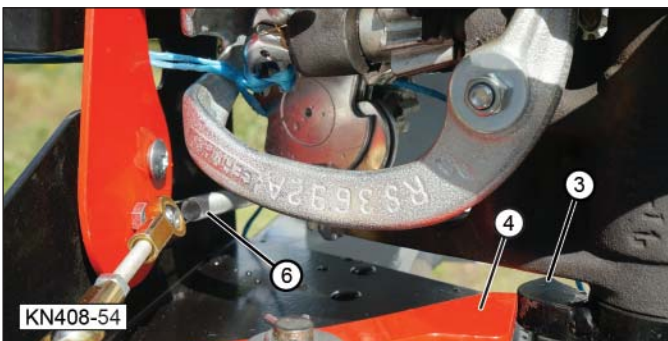
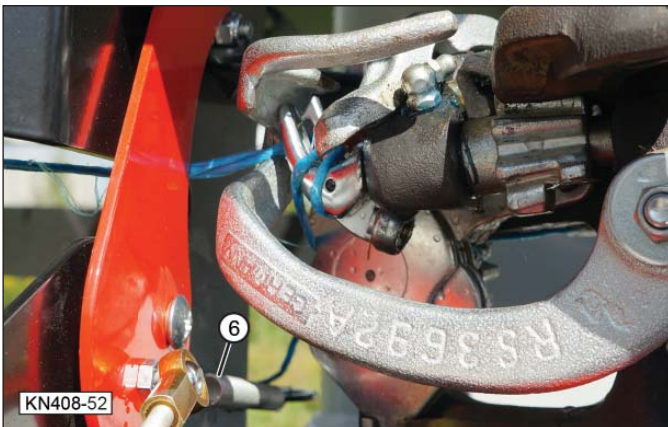

## NOTICE

The rocker arm and the stripper finger can come into contact with each other, resulting in damage, if the timing of these moving parts is incorrect.

7. In this illustration, the bill hook finger has made one complete revolution. As the rocker arm pulls the tucker finger downward, stripper arm (7) slides the knot off bill hook finger (3) and the knot is tied.

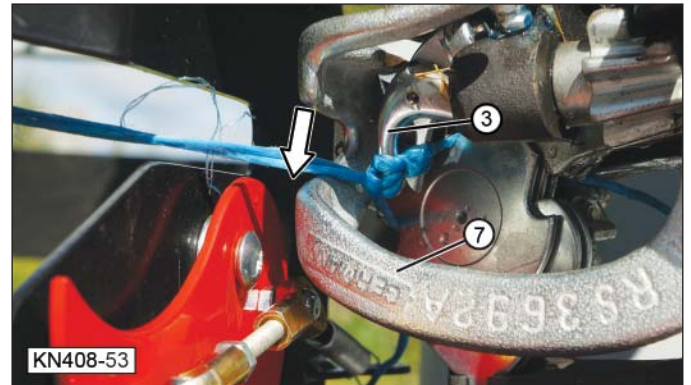

### Knotter Maintenance

#### Twine Arm Stop Bumper

The twine arm stop bumper prevents metal-to-metal contact between the twine arm and frame. This rubber stop should be checked periodically for wear or damage and replaced as necessary.



## Tucker Finger Adjustment

If the tucker finger does not extend far enough into the knotter, shorten the linkage (turn clockwise).

1. Loosen locknut (1).

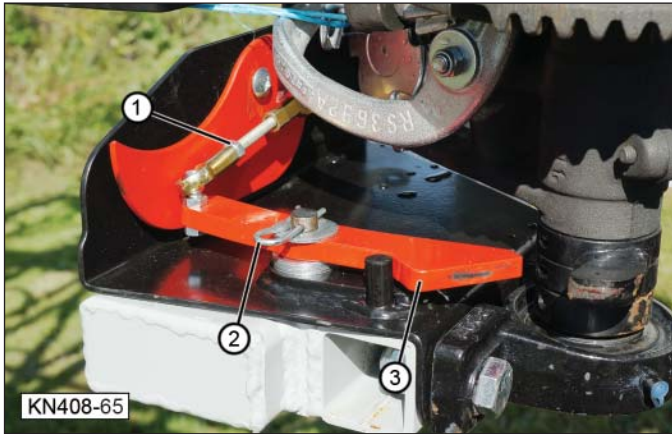

2. Remove hairpin clip and washer (2).
3. Remove rocker arm (3) from pivot shaft.
4. Rotate the rocker arm clockwise to shorten the shaft or counterclockwise to lengthen the shaft.

**Note:** Only rotate the rocker arm one revolution at a time.

5. Reinstall the rocker arm shaft, washer, and hairpin clip.
6. Cycle the knotter and readjust, as necessary.

## Accessing Knotter Components

Removing bolt (1) allows the knotter assembly to swing out of the frame and into a servicing position for knife blade replacement, bill hook adjustment, stripping cam adjustment, etc.



## Bill Hook Adjustment

If the clamping force on bill hook (2) is not adjusted properly it can cause the knotter to break the knot or tie it too loosely.

- If the bill hook is clamping too tightly, the knot will jam in the mouth of the bill hook (3) and the twine will break.
- If the bill hook is not clamping tightly enough, the knot will not tie or it will be loose loops of twine.

1. Adjust locknut (1) to either increase or decrease the clamping force of the bill hook on spring plate (4). Tightening or loosening the locknut adds or decreases tension to spring plate (4) which in turn adds or decreases tension to the bill hook.

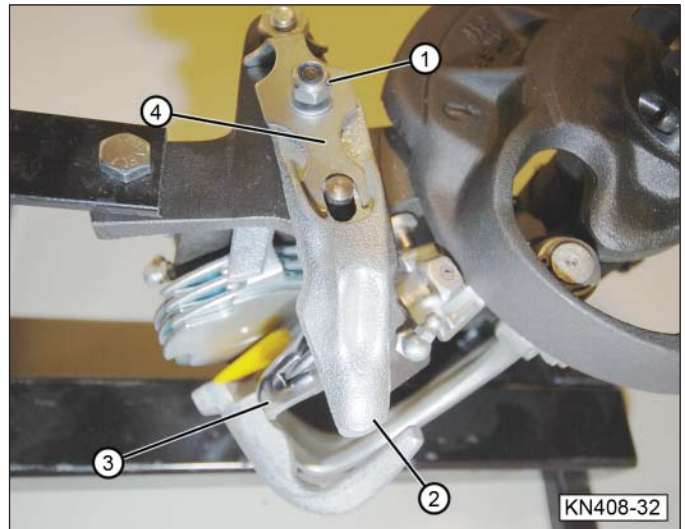

2. Cycle the knotter and adjust, as necessary.

## Twine Disc Assembly

The twine disc assembly holds one end of the twine in place until the needle of the twine arm brings the other end into the knotter. To adjust:

1. Loosen nut (2) until there is a 1/32" (1 mm) gap between the nut and worm gear (3).
2. Lightly tap the nut (shaft) to loosen the worm gear.
3. Rotate twine disc assembly (1) to the desired position.
4. Tighten nut (2) to 18.5 lb. ft. (25 N·m).
5. Cycle the knotter and recheck the position of the discs.

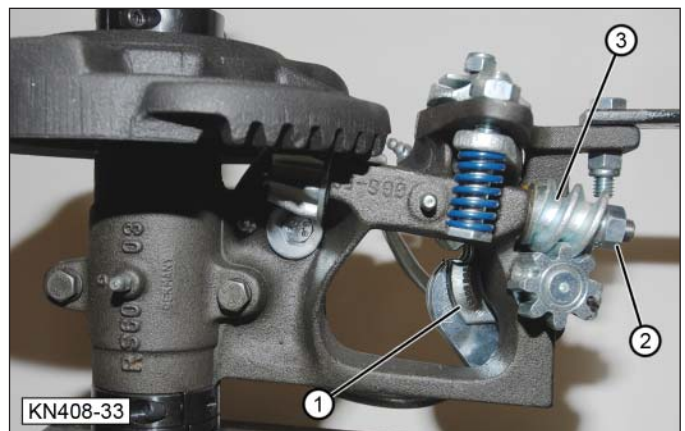



## Twine Clamping Force

The clamping force of the twine holder should hold the twine tightly enough to prevent it from slipping out of the clamping device during the tying cycle. If necessary, increase or decrease the clamping force. If the clamping force is too great, it will tear or fray the twine.

1. Adjust nut (1) to either increase or decrease the clamping force of twine holder (2).
2. Cycle the knotter and recheck on the twine.
3. Readjust nut (1), as necessary.

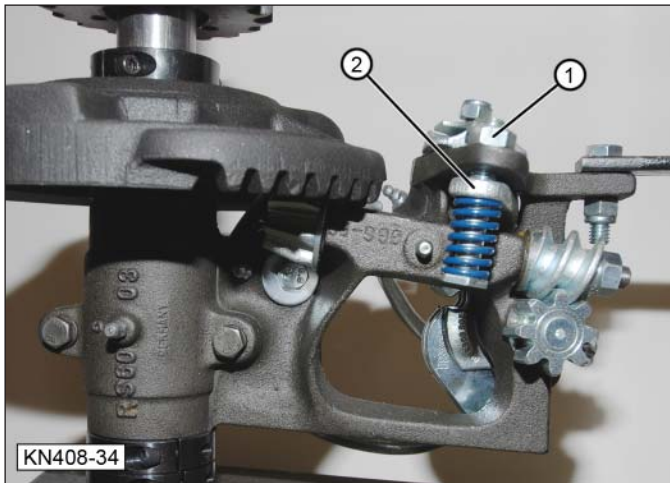

1. To adjust knife arm (3), release the knotter frame to gain access to the knife arm.
2. Bend the knife arm to the desired position, using an appropriate bending tool.
3. Cycle the knotter and recheck the knife arm position.
4. Re-adjust knife arm, if necessary.

## Stripping Arm

Stripping arm (2) must slide smoothly over bill hook finger (1) with slight contact to strip the knot off of the bill hook finger.



## Knife Arm

- The knife arm should be adjusted to allow bill hook finger (1) to rotate freely, but not contact knife arm (3).
- The twine guide area (2) must be kept smooth to prevent twine breakage. Once a groove begins to wear into the twine guide area, knife arm (3) must be replaced.
- Replace knife (5) as soon as the knot begins to have excess twine on the end or the twine is frayed.

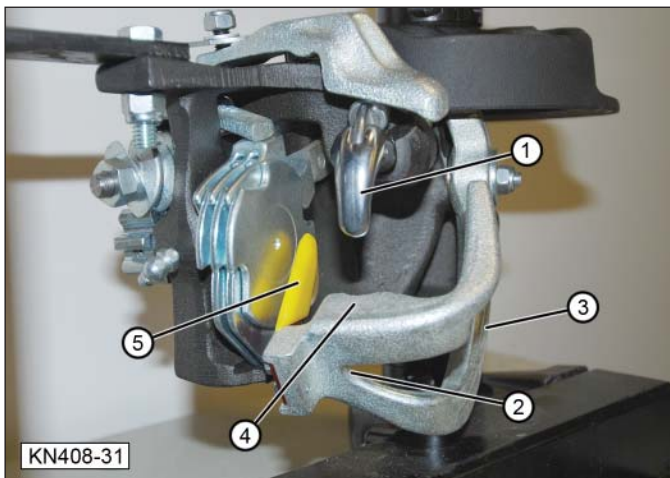

**Note:** There should not be a gap between the bill hook finger and the the stripper arm.





## Cam Gear Adjustment

The gap (1) between the hub face and the cam gear should not exceed 0.016". To adjust this gap, install or remove flat shims under the hub face in location (2).

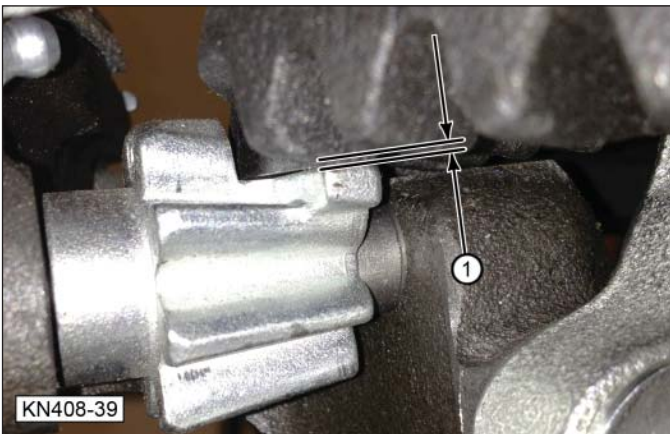
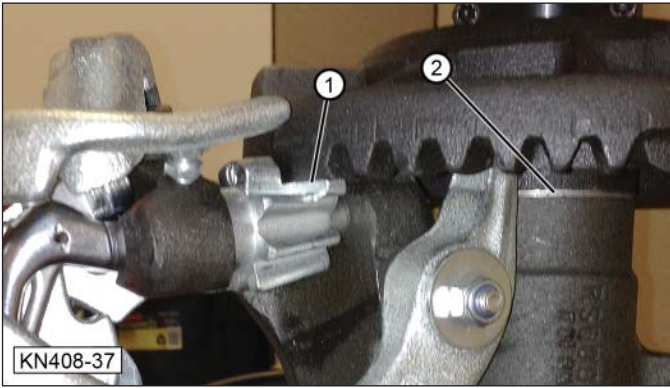

If the knotter is not working properly, make sure the stop collar (3) is holding the cam plate firmly down and the collar lock screw is tight.



## Lubrication

### Main Frame

The following locations should be lubricated every 75 to 100 cycles of the machine. Add grease to each zerk until grease it comes out of the bushing.

1. Lubricate swing arm drive shaft.



2. Lubricate two squeeze arm pivot shafts.



3. Lubricate two motor shaft bearings.

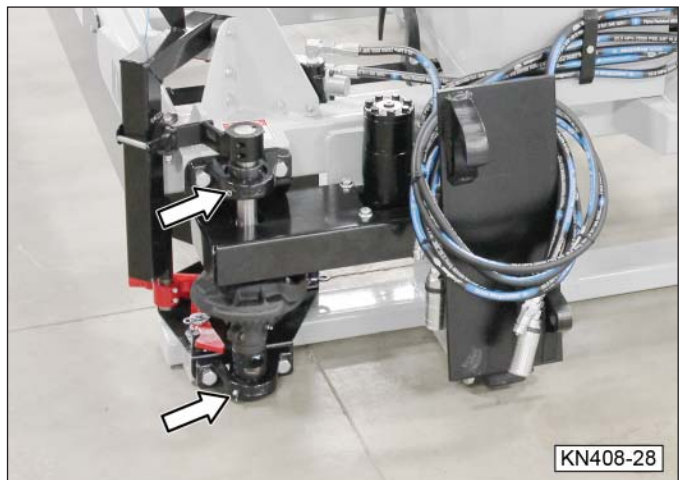

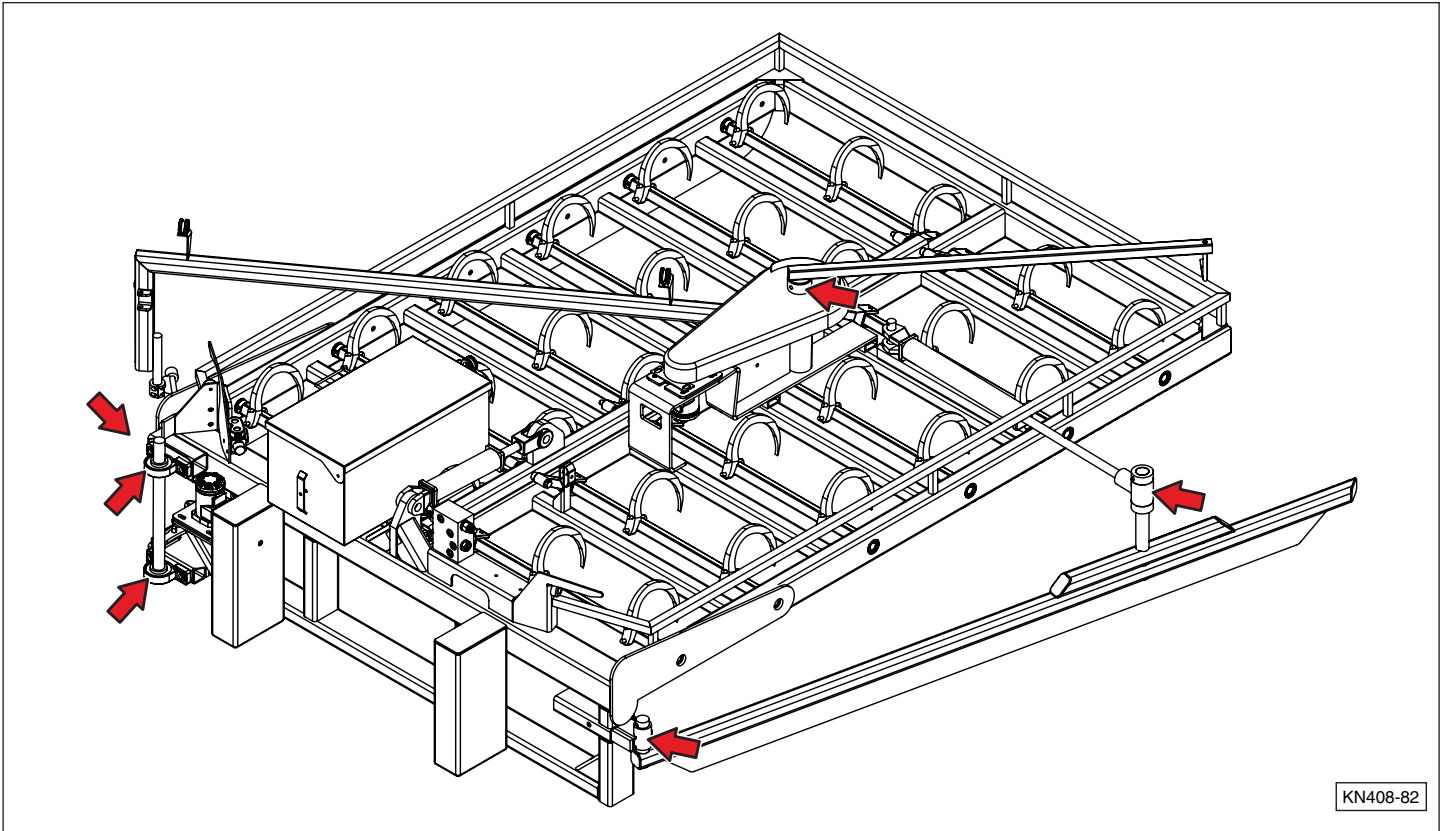

KN408-82

### Knotter Lubrication

1. Remove old grease, dirt, twine debris, etc. before applying new grease.
1. Apply grease to the five knotter grease zerks daily, before each use.
2. Lightly grease the sliding surfaces and gear teeth of the cam gears daily.



KN408-27

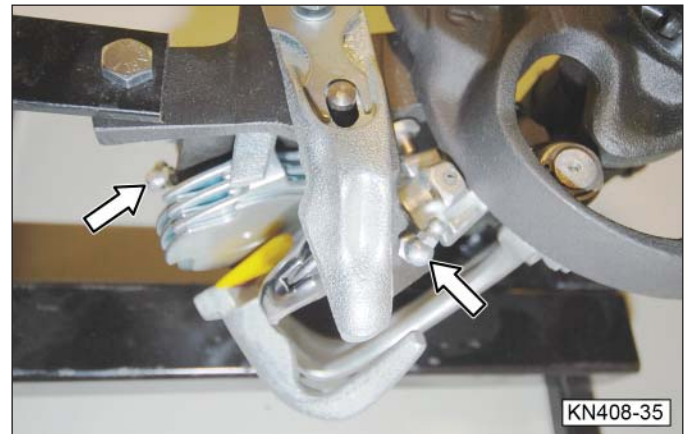

KN408-35

## Storage

### **WARNING**

Not following these safety instructions can result in serious injury and possible death.



Read and understand the Operator's Manual and all safety signs before moving the unit.



Do not permit anyone, especially children to play on or around the stored unit.

1. Store the unit in an area away from human activity.
2. Store the unit in a dry, level area.
3. Do not set the unit directly on the ground. Place hay bales or a support stand under the front of the frame.

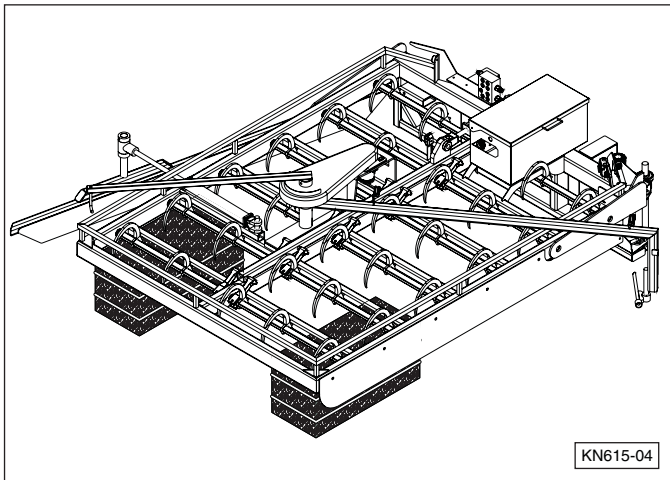

### **NOTICE**

Setting the unit directly on the ground can damage the squeeze arm and will void the warranty.

# NOTES



# Manifold Hose and Valve Locations

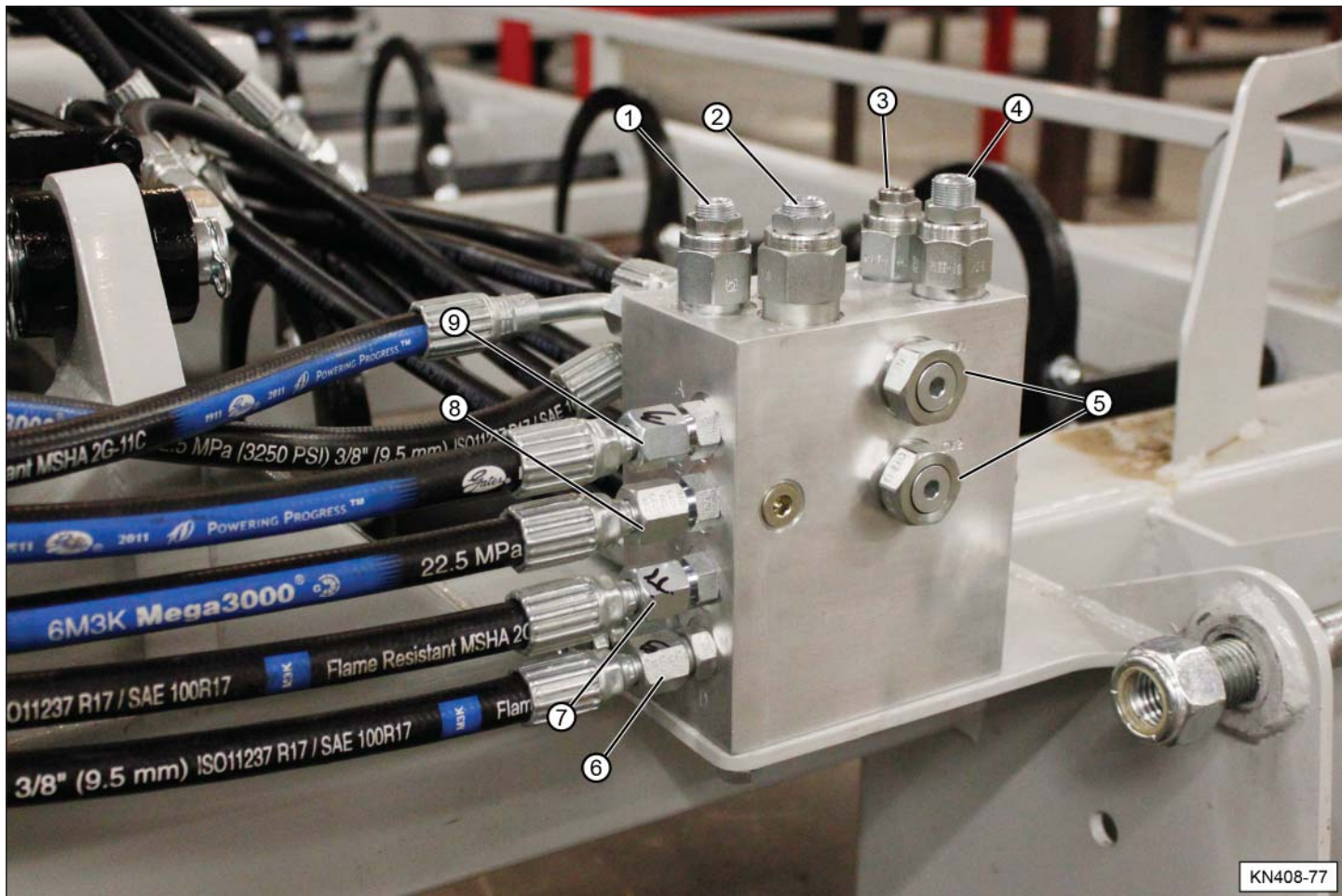

Item	Description
1	Knotter Speed Needle Valve
2	Twine Arm Forward Speed
3	Twine Arm Return Speed
4	Crossover Relief Valve
5	Check Valves, Non-Adjustable
6	Squeeze Arm and Hook Return
7	Squeeze Arm and Hook Pressure
8	Twine Arm and Knotter Pressure
9	Twine Arm and Knotter Return



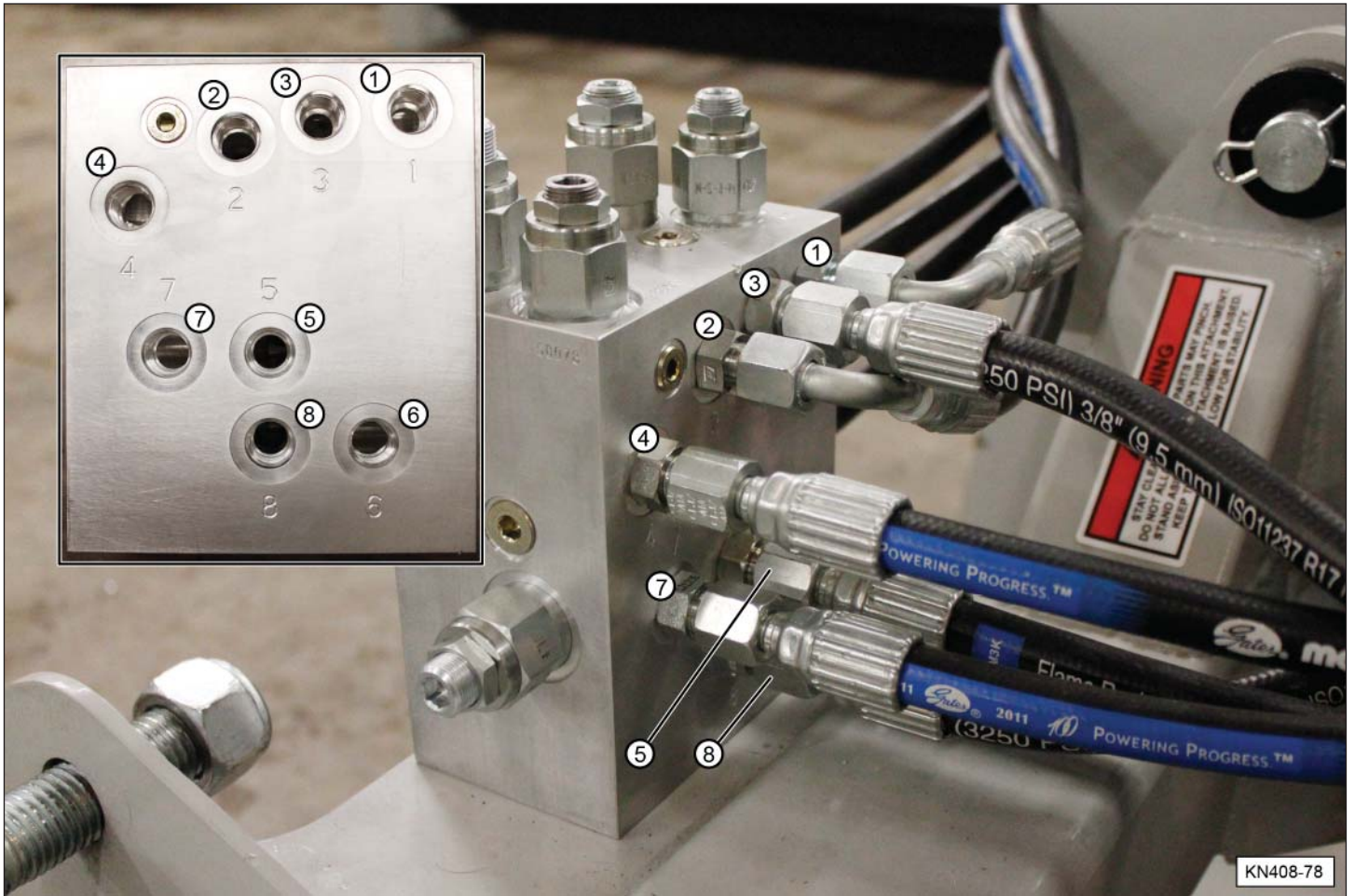

# Manifold Hose and Valve Locations (continued)

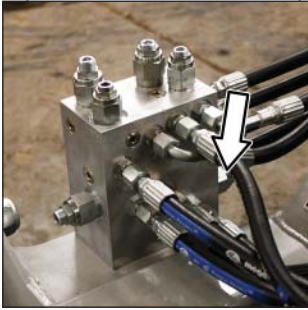
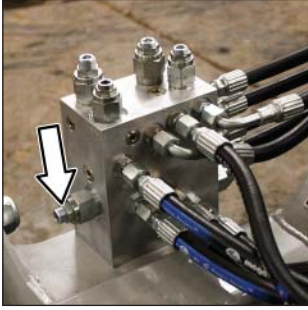
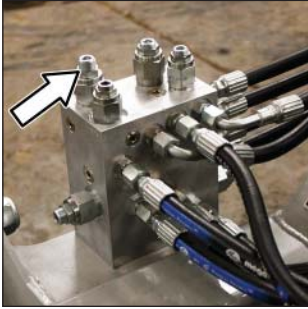

Item	Description
1	Knotter motor pressure - to plunger valve
2	Knotter motor return - from knotter motor
3	Twine arm forward - to twine arm motor
4	Twine arm return - from twine arm motor
5	Squeeze arm close - to cap end of cylinder
6	Squeeze arm open - to rod end of cylinder
7	Hook set - to cap end of cylinder
8	Hook release - to rod end cylinder

# Troubleshooting

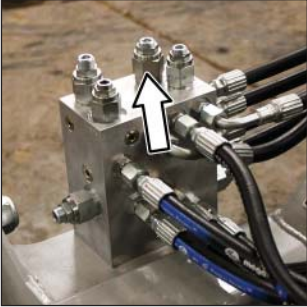
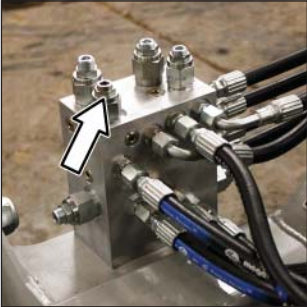
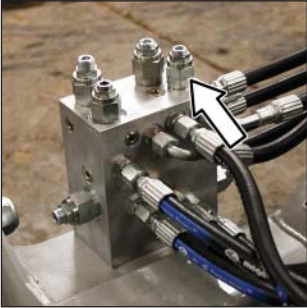
Problem	Cause	Solution
<b>Sequence Valves for Hooks and Squeeze Arm</b>		
<p>Hooks are set into the bales before the squeeze arm closes completely.</p> 	<p>Sequence valve is improperly adjusted.</p>	<p>Adjust sequence valve in a CW direction. Adjustments should be no more than 1/4 turn at a time. Retest the operation between each adjustment.</p> <p>Check for proper adjustment. The initial setting should be 3-3/4 turns from a complete closed position.</p> <p>If adjustments do not affect the timing of the hooks to the squeeze arm, replace sequence valve.</p>
<p>Squeeze arm opens before hooks release.</p> 	<p>Sequence valve is improperly adjusted.</p>	<p>Adjust sequence valve in a CCW direction. Adjustments should be no more than 1/4 turn at a time. Retest the operation between each adjustment.</p> <p>Check for proper adjustment. The initial setting should be 3-3/4 turns from a complete closed position.</p>
<b>Crossover Relief Valve</b>		
<p>Twine arm does not feed into knotter and start knotter cycle.</p> 	<p>Not enough pressure to start knotter cycle.</p>	<p>Adjust valve in a CW direction to increase the pressure. Adjustments should be no more than 1/4 turn at a time. Retest the operation between each adjustment.</p> <p>Check for proper adjustment. The initial setting should be 4-3/4 turns from a complete closed position.</p>

Problem	Cause	Solution
<b>Flow Control Valves</b>		
<p>Twine arm speed into knotter is too fast.</p> 	<p>Flow control valve setting is too high.</p>	<p>Adjust the flow control valve CW to reduce the speed.</p>
<p>Twine arm does not return or slowly returns to the retracted position.</p> 	<p>Flow control valve setting is too low.</p>	<p>Adjust the flow control valve CCW to increase the speed.</p>
<b>Needle Valve</b>		
<p>Knotter does not rotate or turns too slowly to properly tie the knot.</p> 	<p>Pressure is too low.</p>	<p>Adjust the needle valve CCW to increase the speed.</p>
<b>Knotter Plunger Valve</b>		
<p>Knotter does not rotate or rotates slowly.</p> 	<p>Spool of plunger valve is not being depressed far enough.</p>	<p>Adjust the stop bolt so snap ring is within 1/16 inch from face of valve body.</p>
<p>Hydraulic pressure to knotter motor; rotation does stop.</p>	<p>The plunger valve for knotter motor rotation is not being activated.</p>	<p>Adjust stop bolt on valve assembly.</p>

Problem	Cause	Solution
<b>Knotter</b>		
Knotter is not functioning correctly.	Contact between knotter shaft cam and rocker arm is out of time.	Reposition the cam using the split line between the two piece casting of the knotter.
	Tucker finger is not returning to retracted position.	Spring is stretched, missing, or broken. Replace spring.
	Twine is not being held properly with tucker finger (not extending far enough into the knotter).	Remove the rocker arm and adjust the position of the tucker finger.
	The needle is not set correctly in relationship to the twine holder.	Set the needle 1/8 inch from the face of the twine holder. See "Needle Position Within the Knotter" section in this manual.
Twine arm makes loud metallic sound when it contacts the stop.	Twine arm bumper stop is missing.	Replace rubber stop.
Twine is not wrapping around the bales correctly.	Twine is not catching the twine hook at the front of the unit.	Reposition twine hook to catch the twine as the twine arm returns to its retracted position.



## Troubleshooting Valve Settings

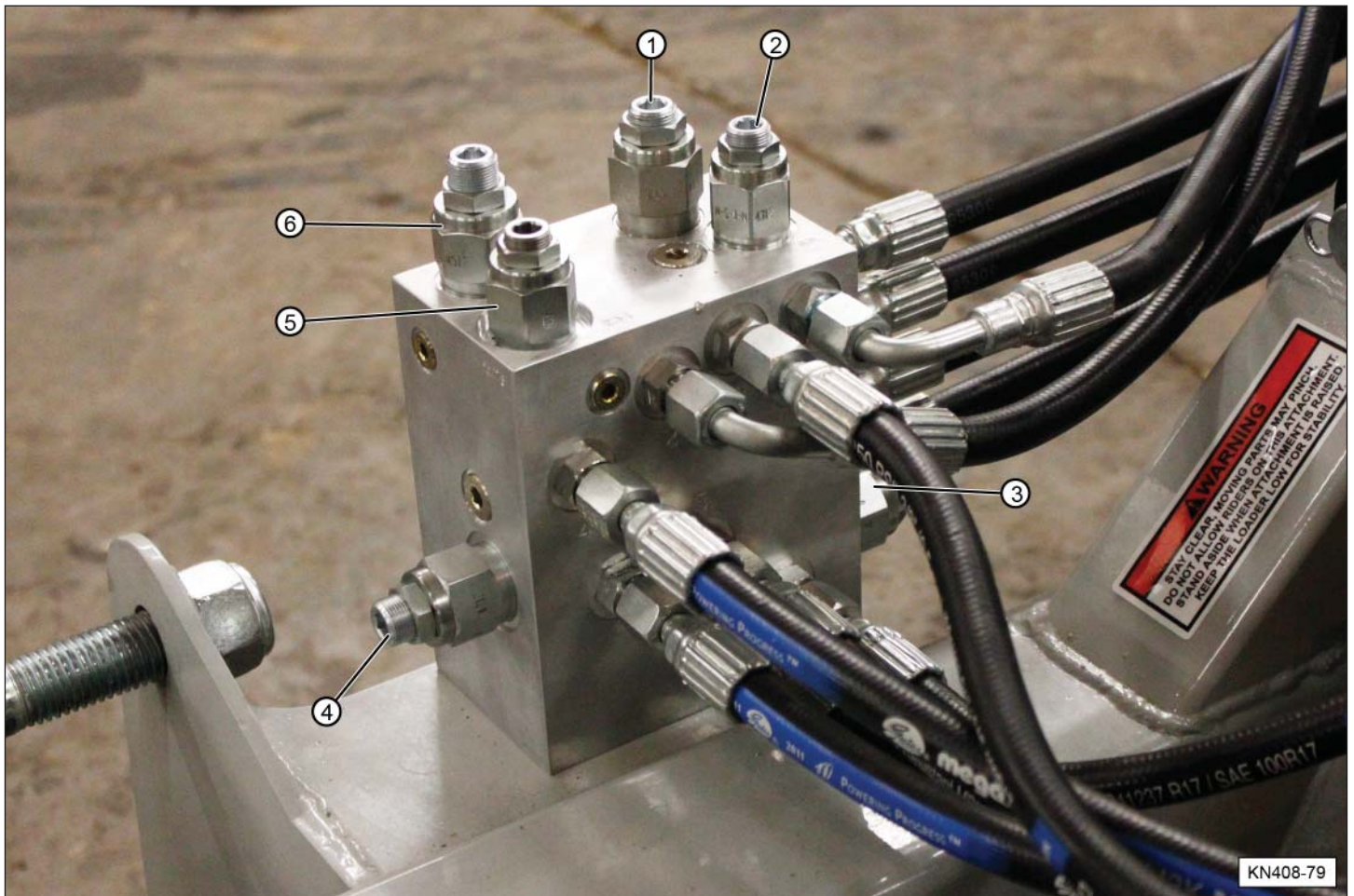

Item	Description and Adjustment Specifications
1	Twine Arm Forward Speed FLOW Control Valve CW - Decrease Speed CCW - Increase Speed Initial setting 1/8 turn from complete closed position.
2	Knotter Speed Needle Valve CW - Decrease Speed CCW - Increase Speed Initial setting 2-1/8 turns from complete closed position.
3	Sequence Valve; Release Hooks, Squeeze Arm Open CW - Decrease Speed CCW - Increase Speed Initial setting 3-3/4 turn from complete closed position.
4	Sequence Valve; Set Hooks, Squeeze Arm Close CW - Decrease Speed CCW - Increase Speed Initial setting 3-3/4 turn from complete closed position.
5	Twine Arm Return Speed Flow Control Valve CW - Decrease Speed CCW - Increase Speed Initial setting 1-1/4 turns from complete closed position.
6	Crossover Relief Valve CW - Decrease Speed CCW - Increase Speed Initial setting 4-3/4 turns from complete closed position.

**Note:** Whenever adjusting the settings on needle valves or relief valves, loosen the jam before making the adjustment with an Allen wrench. Once the valve is adjusted correctly, use the Allen wrench to prevent the valve from turning while tightening the jam nut.

## Parts Section

### Ordering Parts

We manufacture a quality product that requires very little maintenance or repair. However, should a part break or become damaged, our knowledgeable staff can make sure you receive the part(s) to put your unit back into operation.

### Contact Information

For replacement decals, questions, or to order parts, contact:

**Kuhns Manufacturing**  
**4210 Kinsmann Rd. NW**  
**North Bloomfield, OH 44450**

**Phone: 877-296-5851**

**Fax: 440-693-4336**

**E-mail: [parts@kuhnsmfg.com](mailto:parts@kuhnsmfg.com)**

### Decals

## **WARNING**



**To prevent serious injury or death from not following posted safety instructions, make sure all decals are attached to the unit and are legible at all times.**

Safety decals provide a vital role in helping to reduce injuries and/or possibly even death. To ensure the greatest level of safety, all decals must be in place and legible at all times. Remember, it is the users responsibility to maintain these decals.

All decals must be in place and legible or all warranties are void.



# Tie Grabber Frame and Squeeze Arm

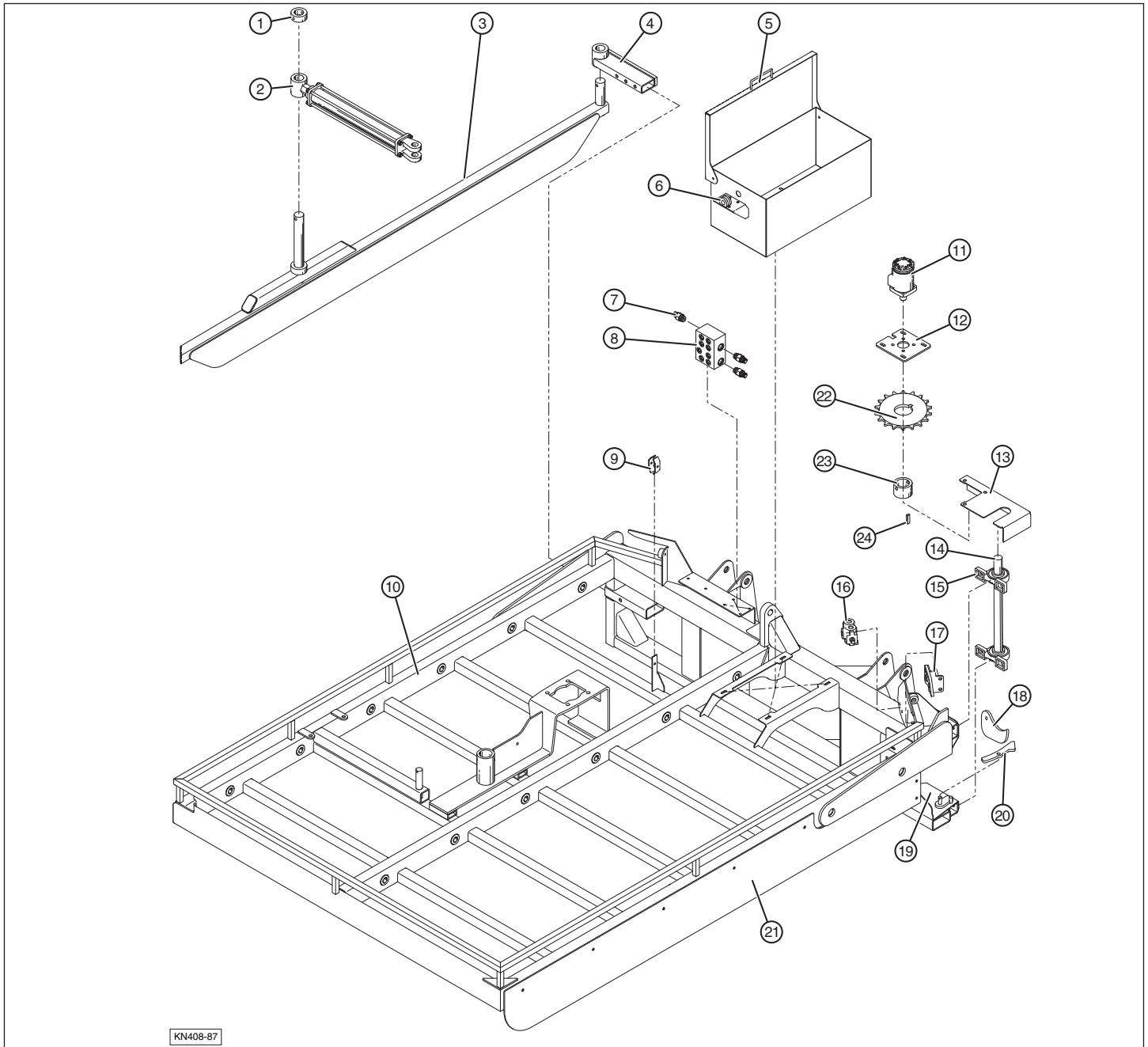

KN408-87

Item	Part Number	Description	Qty.
1	T-142	Collar, Front	1
2	Hyd-20008	Cylinder, Hydraulic, 2" x 16"	1
3	T-100	Arm, Squeeze	1
4	T-141	Bracket, Squeeze Arm, Rear	1
5	T-191	Twine Box	1
6	T-193	Twine Guide, Ceramic	1
7	Hyd-500	Insert, Hydraulic Valve	*
8	Hyd-1	Block, Hydraulic	1
9	T-192	Clamps, Hose Holder	*
10	T-2	Frame, Main	1
11	Hyd-202	Motor, Hydraulic	1
12	Hyd-601	Mounting Plate, Hydraulic Motor	1

Item	Part Number	Description	Qty.
13	T-190	Chain Guard, Knotter	1
14	T-162	Shaft, Knotter	1
15	PT-04	Bearing, Knotter	2
16	Hyd-401	Valve, Plunger	1
17	T-164	Valve, Plunger Activator	1
18	T-165	Finger, Tucker	1
19	Hyd-601	Plate, Mounting, Knotter	1
20	T-163	Arm, Rocker	1
21	T-120	Plate, Stop	1
22	PT-203	Sprocket, #50, 19-Tooth, 1" Shaft	1
23	PT-202	Sleeve, Sprocket, #50, 19-Tooth	1
24	PT-300	Key	1

\* Quantities vary by model

# Bale Hook Assembly

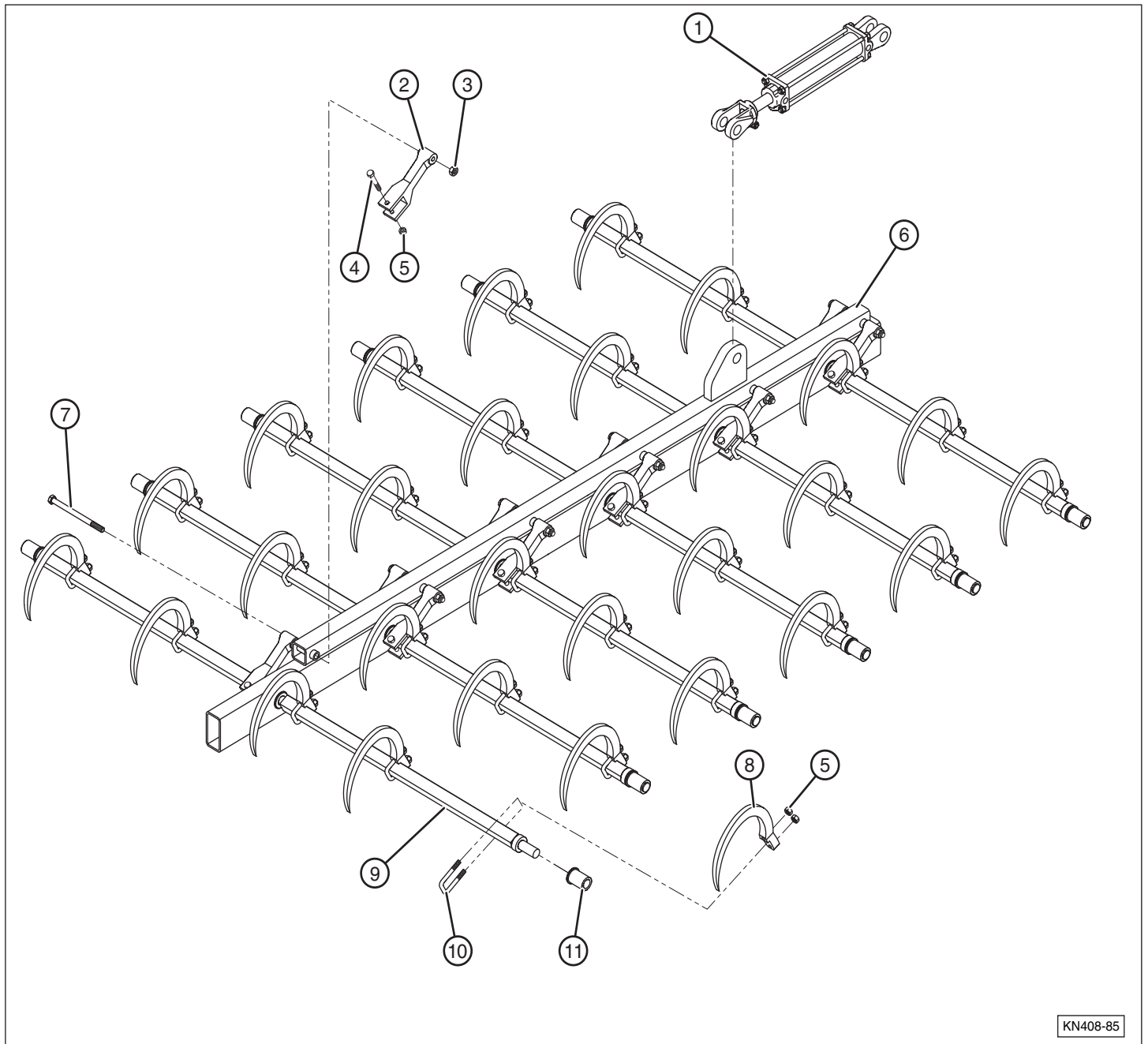

KN408-85

Item	Part Number	Description	Qty.
1	Hyd-20008A	Cylinder, Hydraulic, ASAE, 2" x 8"	1
2	G-62	Arm, Actuator	*
3	F-012LN	Nut, Lock, 1/2"	*
4	F-5038212	Bolt, 3/8" x 2-1/2", Grade 5	*
5	F-038FN	Nut, Flange, 3/8"	*
6	G-10	Bar, Center	1
7	F-5012700	Bolt, 1/2" x 7", Grade 5	*
8	G-21	Hook, Bale	*
9	G-40	Tube, Square	*
10	F-BR81106	U-Bolt, Square, 3/8" x 1-1/4" x 2-1/2"	*
11	G-51	Bushing, UHMW	*

\* Quantities vary by model



# Twine Arm and Motor Assembly

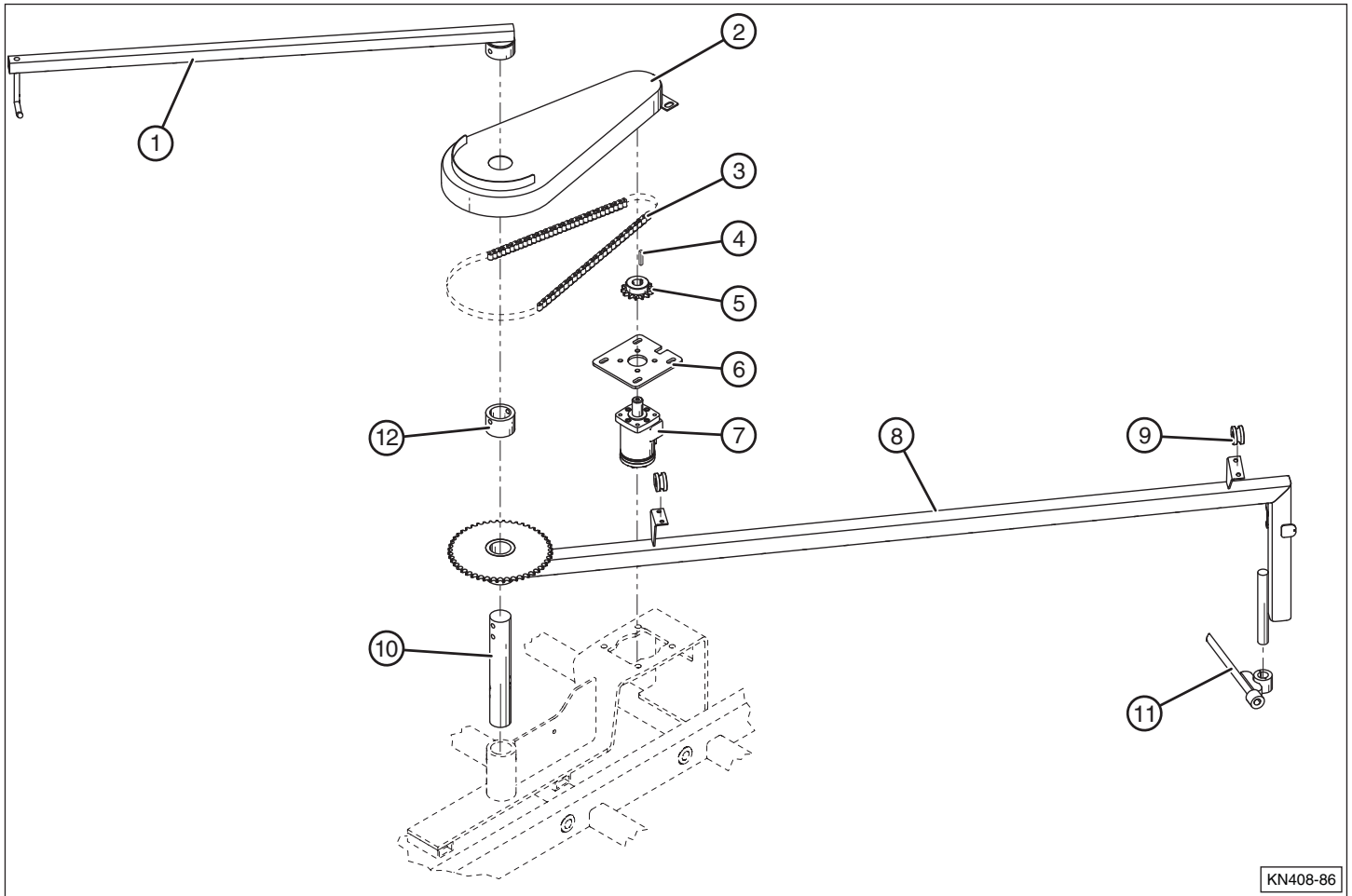

KN408-86

Item	Part Number	Description	Qty.
1	T-80	Catcher, Twine	1
2	T-60	Shield, Chain	1
3	T-351	Chain, #50	1
4	T-300	Key	1
5	PT-201	Sprocket, #50, 14-Tooth, 1" Shaft	1
6	Hyd-601	Plate, Mounting, Motor, Hydraulic	1
7	Hyd-202	Motor, Hydraulic	1
8	T-181	Arm, Twine	1
9	T-193	Guide, Twine, Ceramic	2
10	T-41	Shaft, Twine Arm	1
11	T-43	Needle	1
12	T-42	Collar, Hold Down, Twine Arm	1

# Knotter Assembly

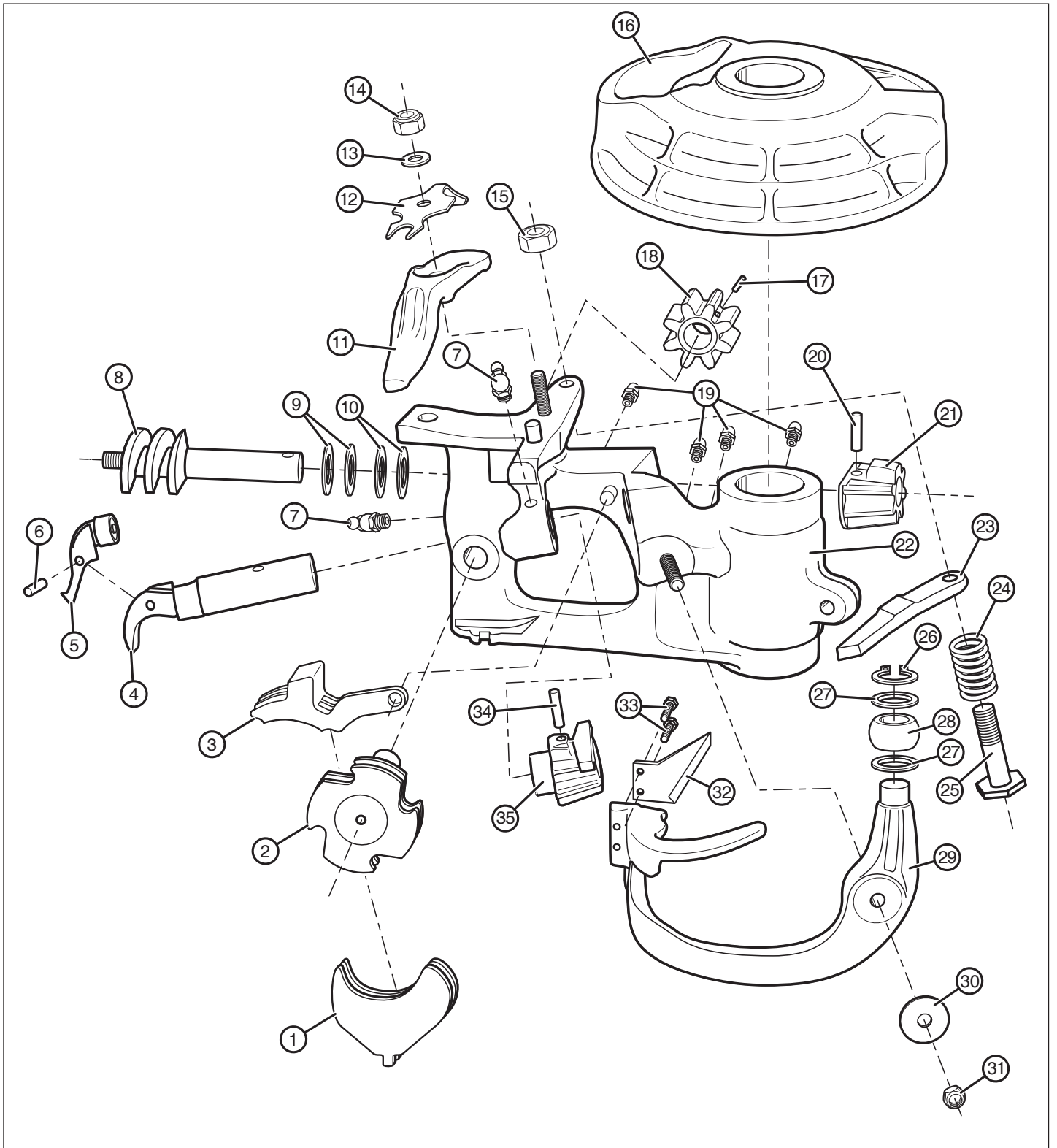



Item	Qty	Part Number	Description
		10-0001	Complete Knotter Assembly
1	2	45-0002	Cleaner, Disc
2	1	45-0003	Driver, Complete
3	1	45-0004	Holder, Twine
4	1	45-0005	Hook, Bill, Complete
5	1	—	Finger, Hook, Bill (not serviced separately)
6	1	—	Pin, Bill (not serviced separately)
7	1	40-0001	Zerk, Grease, 90°
8	1	45-0006	Shaft, Worm, Complete
9	2	45-0007	Shim
10	2	45-0008	Shim
11	1	45-0009	Hook, Bill
12	1	45-0010	Plate, Spring
13	1	40-0002	Washer
14	1	40-0003	Nut, Hex, Nyloc
15	1	40-0004	Nut, Hex
16	1	45-0011	Hub
17	1	40-0005	Pin, Split
18	1	45-0012	Gear
19	4	40-0006	Zerk, Grease, Straight
20	1	40-0007	Pin, Split
21	1	45-0013	Gear, Bevel
22	1	45-0014	Frame, Knotter
23	1		
24	1	45-0015	Spring
25	1	45-0016	Bolt, Hex
26		45-0017	Clip, Spring
27	2	45-0018	Shim
28	1	45-0019	Roller
29	1	45-0020	Arm, Knife
30	1	45-0021	Washer
31	1	45-0022	Nut, Nyloc
32	1	45-0023	Blade, Knife
33	2	45-0024	Bolt, Hex
34	1	45-0025	Pin, Split
35	1	45-0026	Gear, Bevel

# NOTES

# NOTES



# NOTES





Kuhns Mfg LLC  
4210 Kinsman Rd NW  
North Bloomfield, OH 44450

**(877) 296-5851**  
[www.kuhnsmfg.com](http://www.kuhnsmfg.com)